



WEEE DISASSEMBLY INSTRUCTIONS

SUPERMICRO AS -4125GS-TNRT ENCLOSURE

Abstract

This document provides clear guidance for end-of-life recyclers on how to identify and disassemble reportable materials in compliance with the Waste Electrical and Electronic Equipment (WEEE) directive.

Table of Contents

1.	Product Views.....	1
2.	Reportable Materials on AS -4125GS-TNRT	3
3.	Disassemble Instructions	4
3.3	Step-by-Step Disassembly Instructions	6
1.	Removing Cable and Chassis Top Cover	6
2.	Removing Hard Disk Drive (HDD) / Solid State Drive (SDD)	7
3.	Removing Power Supply	9
4.	Removing Add-on Module (AOM)	10
5.	Removing Fan	11
6.	Removing Backplane	11
7.	Removing Graphics Cards.....	12
8.	Removing PCIe Expansion daughterboard	13
9.	Removing Processor	14
10.	Removing DIMM.....	16
11.	Removing the M.2 from the Motherboard	16
12.	Removing Motherboard.....	16
13.	Removing Control Panel.....	17

1. Product Views

Front view



Rear view



Product construct view



Hard Disk Drive/ Solid State Drive



Backplane

Fans

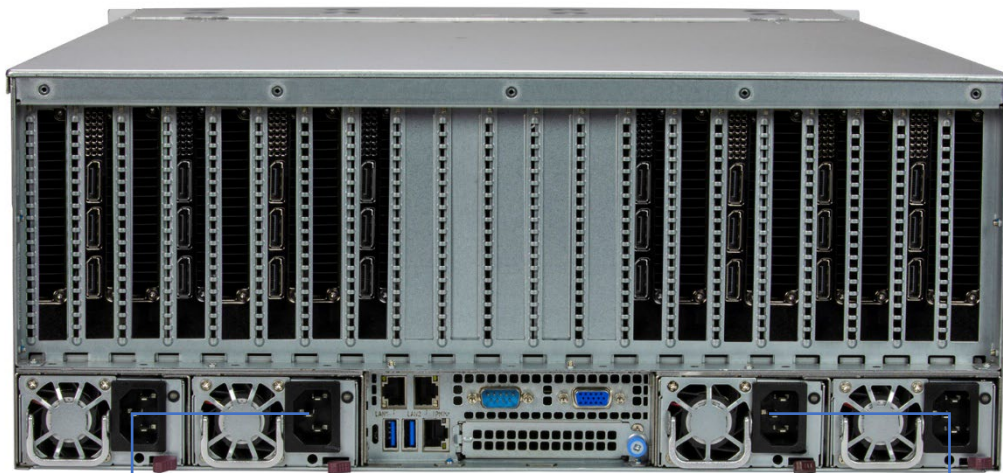

Power Supply

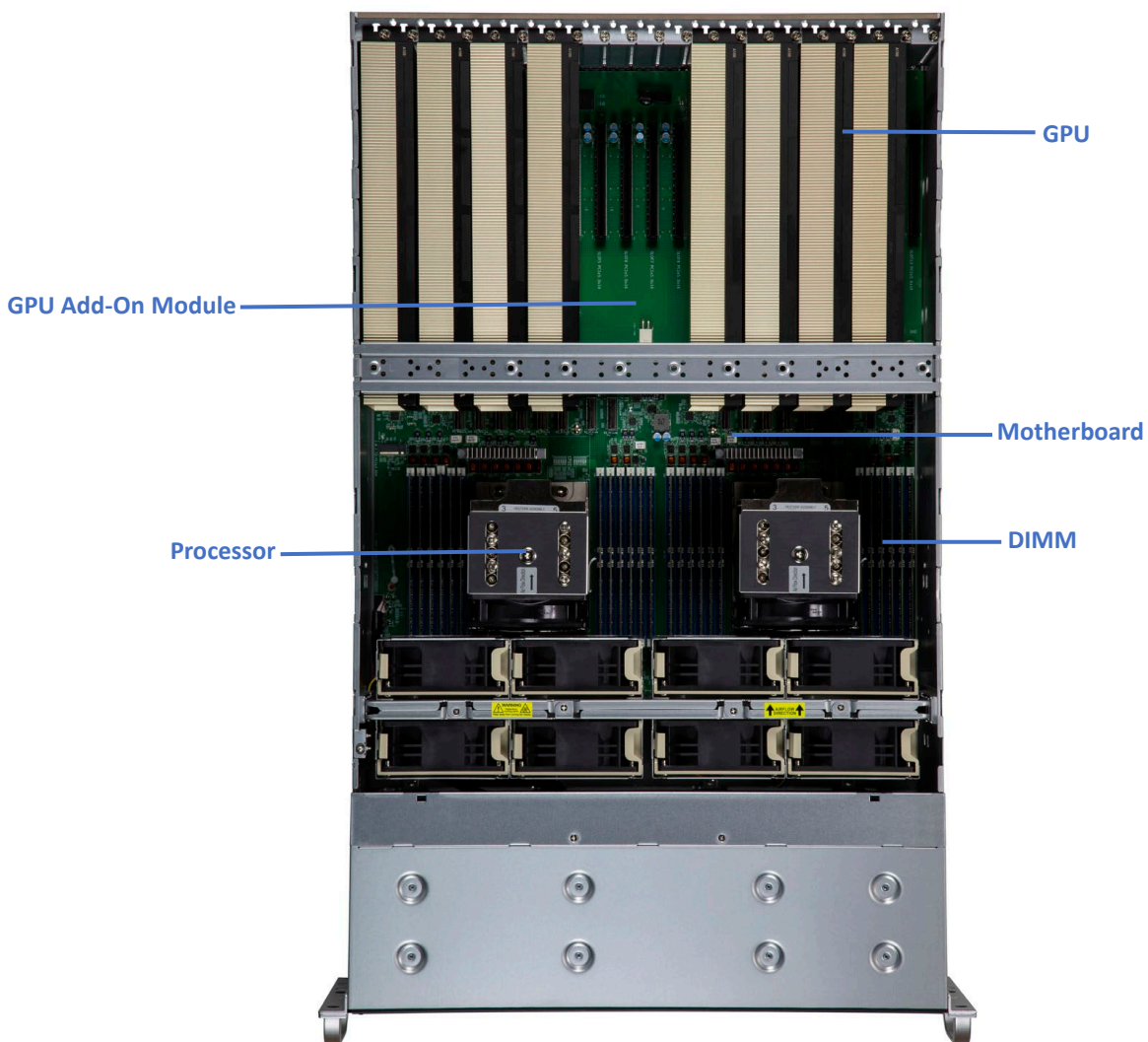

GPU

GPU Add-On Module

Motherboard

Processor

DIMM

2. Reportable Materials on AS -4125GS-TNRT

According to Article 8(2) and Annex VII of WEEE directive 2012/19/EU, below materials and components should be selectively treated.

Description	Notes	No.	Quantity
Printed Circuit Boards (PCB) or Printed Circuit Assemblies (PCA)	With a surface greater than 10 sq cm (Depending on the configuration)	2.3, 3.5, 4.1, 6.2, 7.1, 8.1, 9.2, 10.1, 11.1, 12.1	39
Batteries	All types, including standard alkaline and lithium coin or button style batteries	12.2	1
Mercury-containing components	For example, mercury in lamps, display backlights, scanner lamps, switches, batteries		
Liquid Crystal Displays (LCD) with a surface greater than 100 sq cm	Includes background illuminated displays with gas discharge lamps		
Cathode Ray Tubes (CRT)			
Capacitors / condensers (Containing PCB/PCT)			
Electrolytic Capacitors / Condensers measuring greater than 2.5 cm in diameter or height	Depending on the power supply model	3.6	4
External electrical cables and cords		1.1	4
Gas Discharge Lamps			
Plastics containing Brominated Flame Retardants		13.1, 13.2	4
Components and parts containing toner and ink, including liquids, semi-liquids (gel/paste), and toner	Include the cartridges, print heads, tubes, vent chambers, and service stations.		
Components and waste containing asbestos			
Components, parts, and materials containing refractory ceramic fibers			
Components, parts, and materials containing radioactive substances			



3. Disassemble Instructions

The intent of this document is to provide guidance to recyclers on the presence of materials and components at the product / family level, as required by the EU WEEE Directive 2012/10/EU. This document should also help direct recyclers to proper methods for removing parts and general product disassembly instructions.

This chapter consists of three subsections:





Recommended disassembly tools, disassembled flowchart, and step-by-step disassembly instructions to direct recycler proper methods to treat.

3.1 Recommended Disassembly Tools

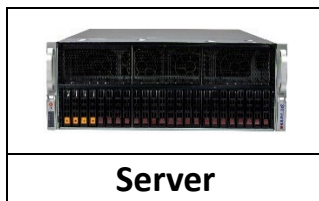
Disassembly tool	Cross screwdriver	
	Flathead screwdriver	



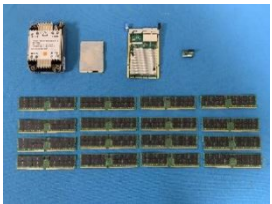

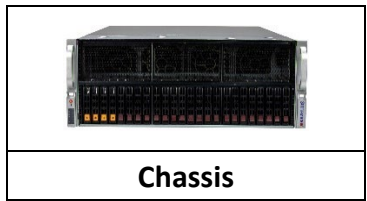

3.2 Disassembled flowchart



			
Chassis	Power Supplies *2 set	RAM, CPU, Heatsink, AIOM Card	Power Cords*2 set

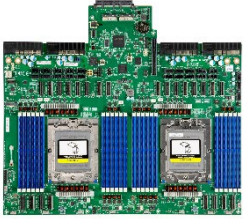

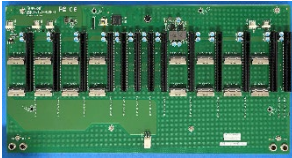

Chassis

			
Backplane	Fans *2 set	Screws	Motherboard
			
Battery	Cables	PCIe Expansion Daughterboard	Graphics Card *4
			
Add-On Module Card			



Power Supply *2

		
Power Enclosure*4	Screws and Standoff*4 Set	Power Supply Module*4

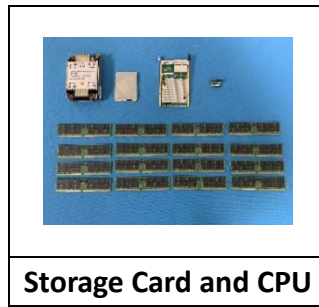

Heat Sink *2	Processor *2	M.2
Add-On TPM Module	DIMM *6 Set	

3.3 Step-by-Step Disassembly Instructions

1. Removing Cable and Chassis Top Cover

1. Use the operating system to power down the system.
2. After the system has completely shut-down, disconnect the power cords from the power supply modules.
3. Remove all cables/ unit from the server IO port.

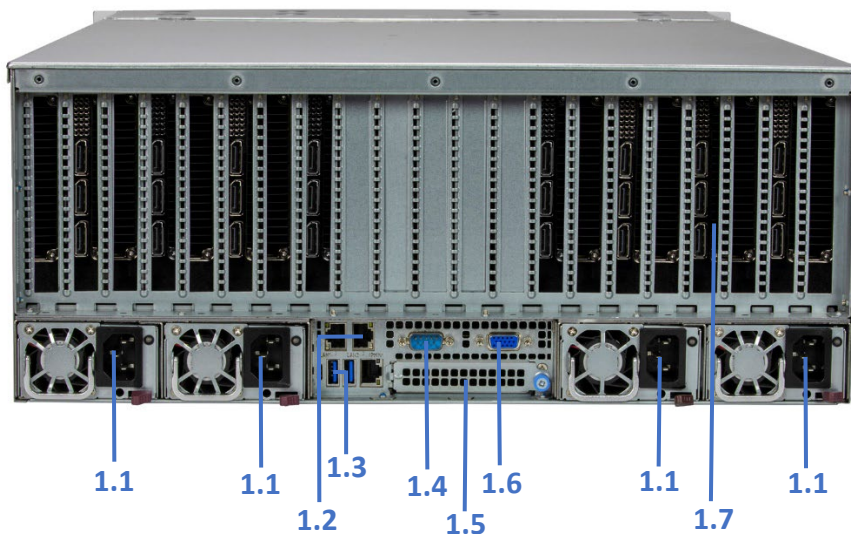

4. The chassis top cover can be lifted off after removing the screws and sliding the cover back and off the system..

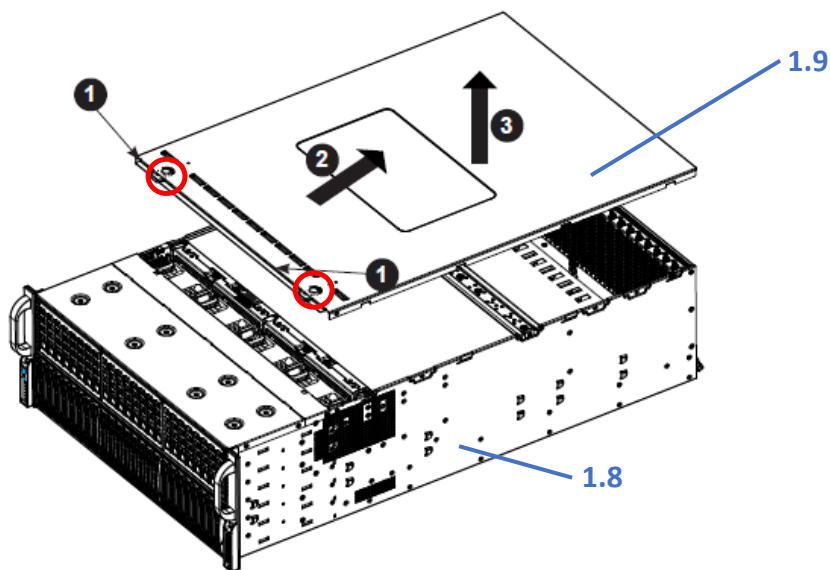

No.	Description	No.	Description
1.1	Power Cable	1.6	Serial Port
1.2	USB 3.0 Ports	1.7	PCIe 5.0 x16 FHFL slots
1.3	BMC LAN Port	1.8	Chassis
1.4	VGA Port	1.9	Top Cover
1.5	PCIe 5.0 x16 AIOM Slot (NCSI)		

2. Removing Hard Disk Drive (HDD) / Solid State Drive (SDD)

1. Press the release button to extend the drive carrier handle.
2. Use the drive carrier handle to pull the drive out of the chassis.

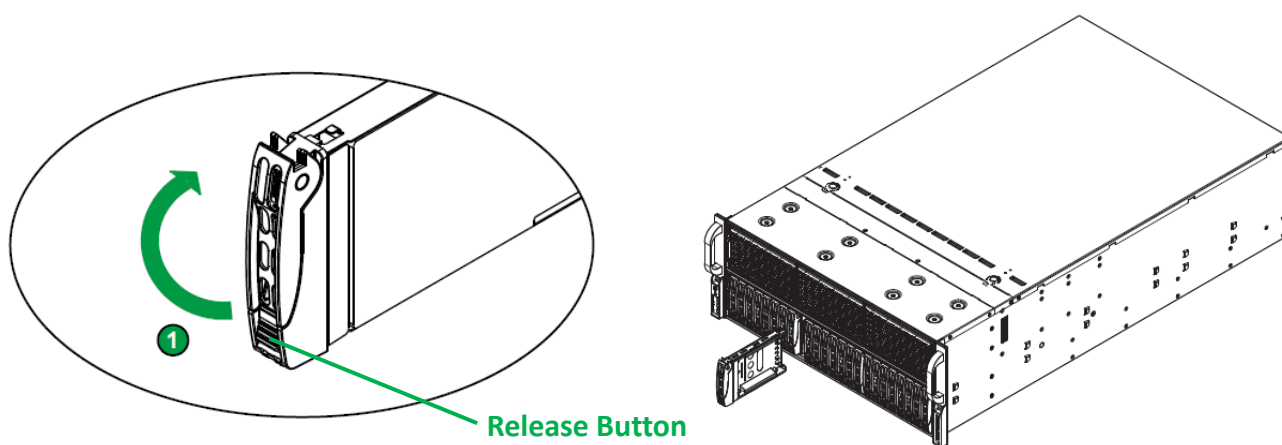

3. Pull and release the locking clasps holding the SSD in place with either a screwdriver flathead or by hand and lift the SSD out from the posts as shown below:

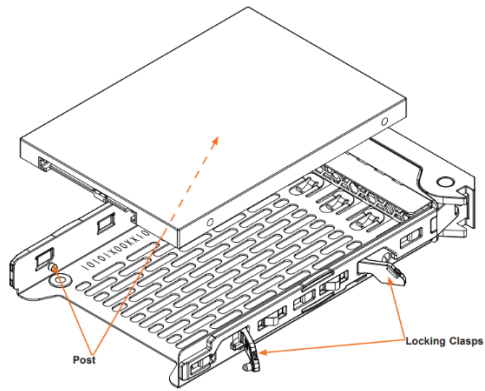

2.1



2.2

5. Use a cross screwdriver to remove drive enclosure

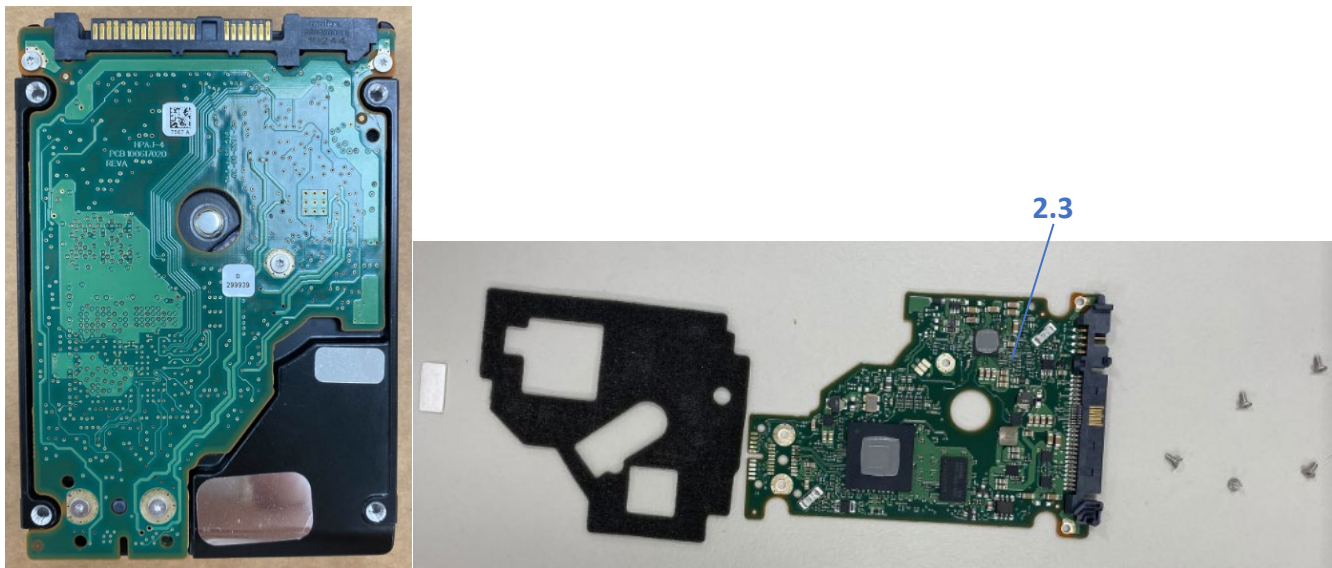

6. Use a cross screwdriver to remove screws and lift off the PCB

No.	Description
2.1	HDD/ SSD
2.2	Hard Drive Enclosure
2.3	Hard Drive PCB

3. Removing Power Supply

1. Press the release tab on the power supply.
2. Use the handle to gently slide the power supply out the back of the chassis.

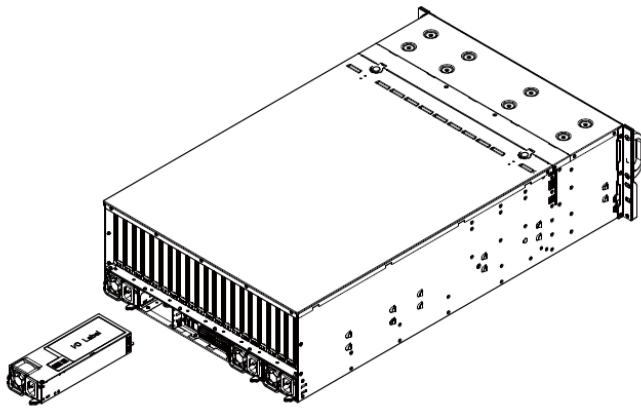

3. Remove the screw from the enclosure



4. Cut the power leads connected to the fan and lift the main board from the chassis

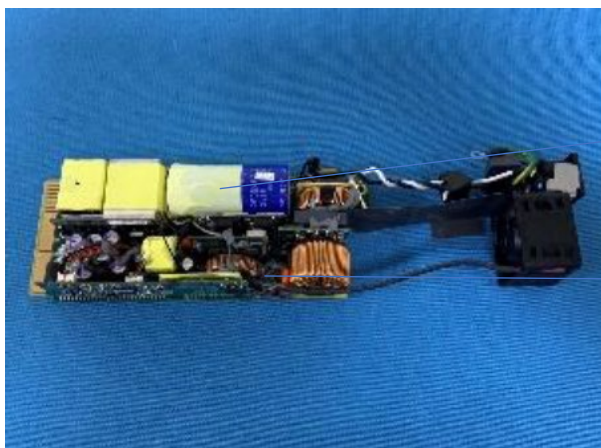

5. Use a flathead screwdriver to cut the capacitor adhesive and pin solder.



No.	Description
3.1	Power Supply
3.2	Power Enclosure
3.3	Fan
3.4	Fan Cable
3.5	Power Module PCB
3.6	Capacitor

4. Removing Add-on Module (AOM)

1. Disconnect the cables attached to the AOM and then lift the AOM out of the chassis and disconnecting from the motherboard in the process.

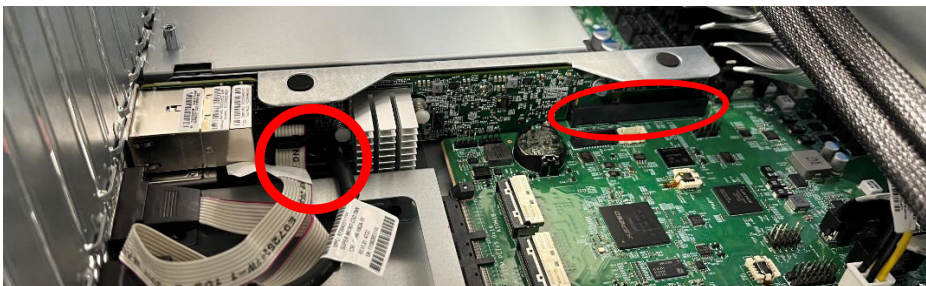

2. Unscrew the screws holding the AOM to the bracket.



No.	Description
4.1	Add-on Module

5. Removing Fan

1. Disconnect the chassis fan from the motherboard fan connectors as shown below.

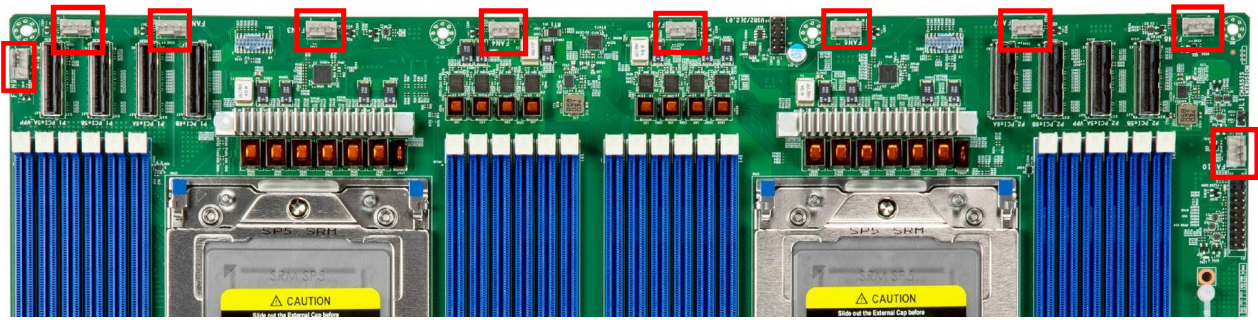

2. Squeeze the fan tabs as circled in red and lift the fan housing up and out of the chassis for each fan.

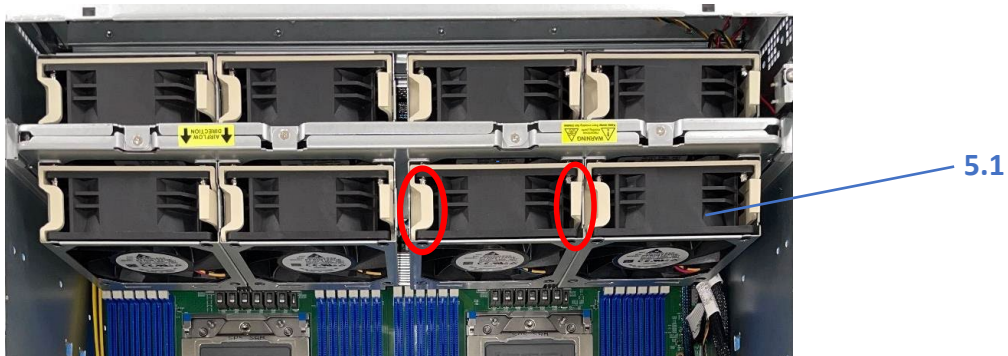

No.	Description
5.1	Cooling Fans

6. Removing Backplane

1. Ensure all cables are disconnected from the backplane and unscrew the backplane bracket from the Chassis **on each side** and bottom as shown.

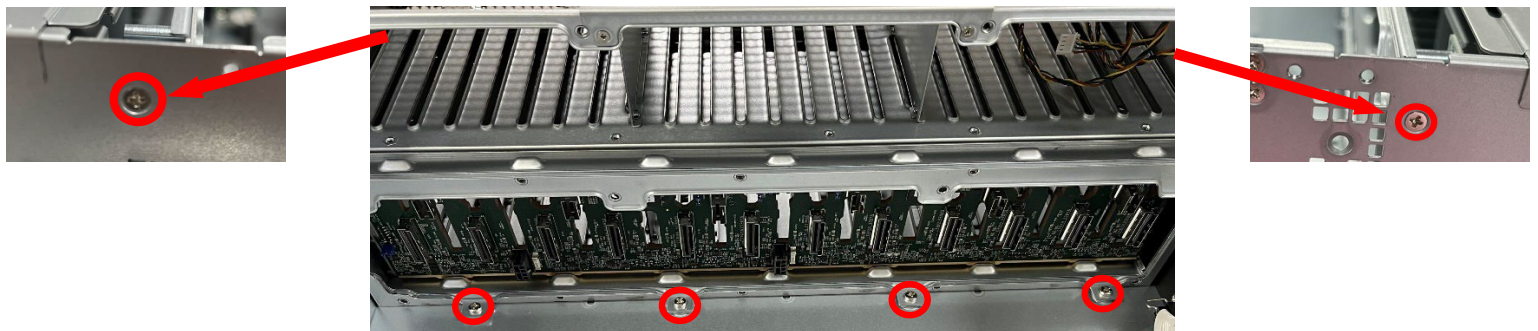

2. Lift the backplane bracket out of the chassis.

3. Unscrew the 4 screws (circled in red) to remove the backplane from the backplane bracket.

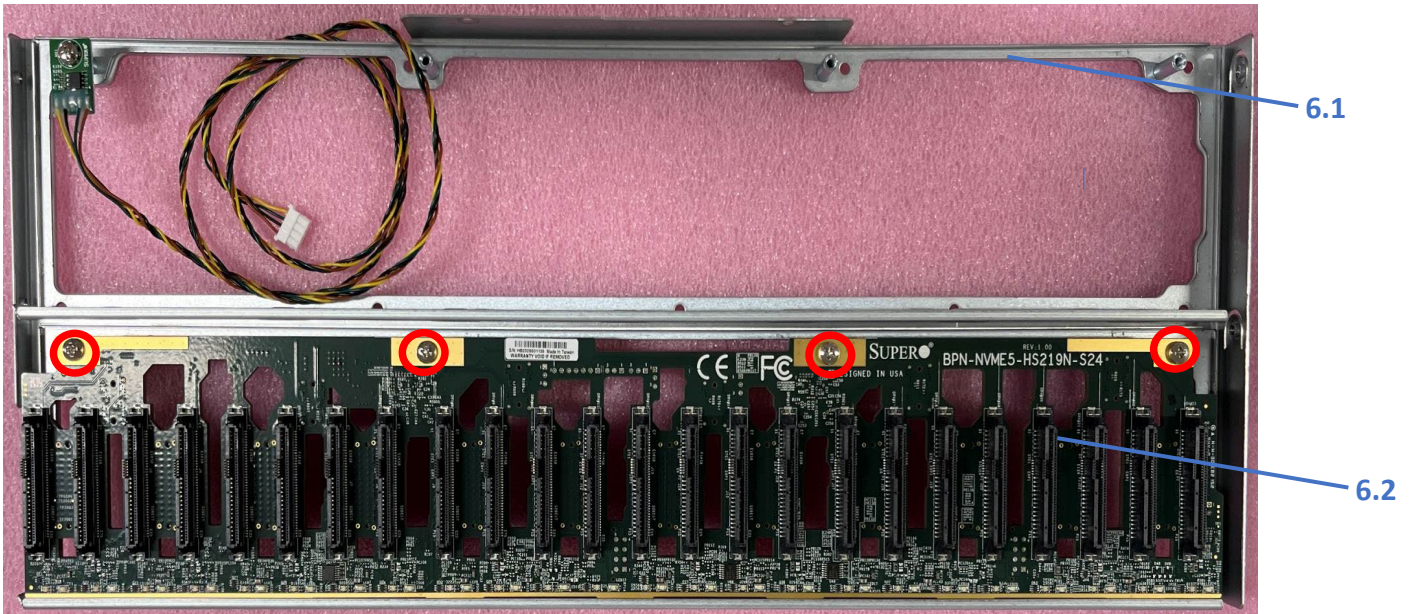

No.	Description
6.1	Backplane Bracket
6.2	Backplane

7. Removing Graphics Cards

1. Disconnect any cables connecting the graphics card.
2. Unscrew the screws holding each of the graphics card in place (circled in red).
3. Unscrew the two screws on each end of the bracket holding the graphics card in place (red rectangle).

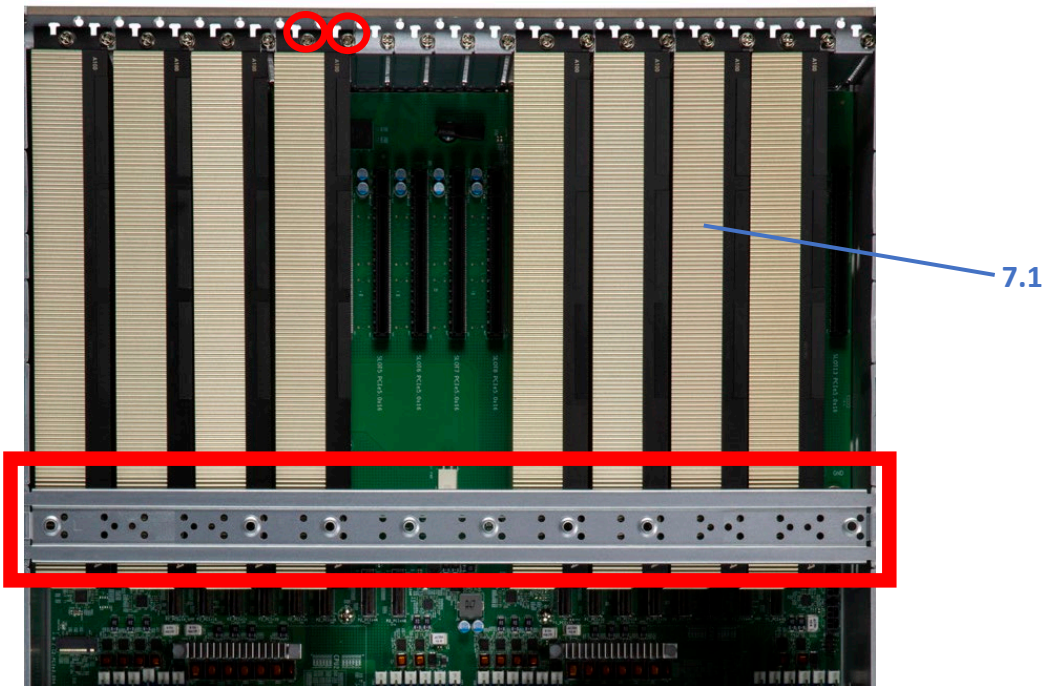

3. Lift the graphics card from the system.

No.	Description
7.1	Graphics Card

8. Removing PCIe Expansion daughterboard

1. Ensure that all cables and GPUs are unplugged and removed from the top side of the expansion card.
2. Unscrew the 4 screws (circled in red) and unlock the lock (circled in blue) and lift the expansion card up to gain access to the bottom of the card.

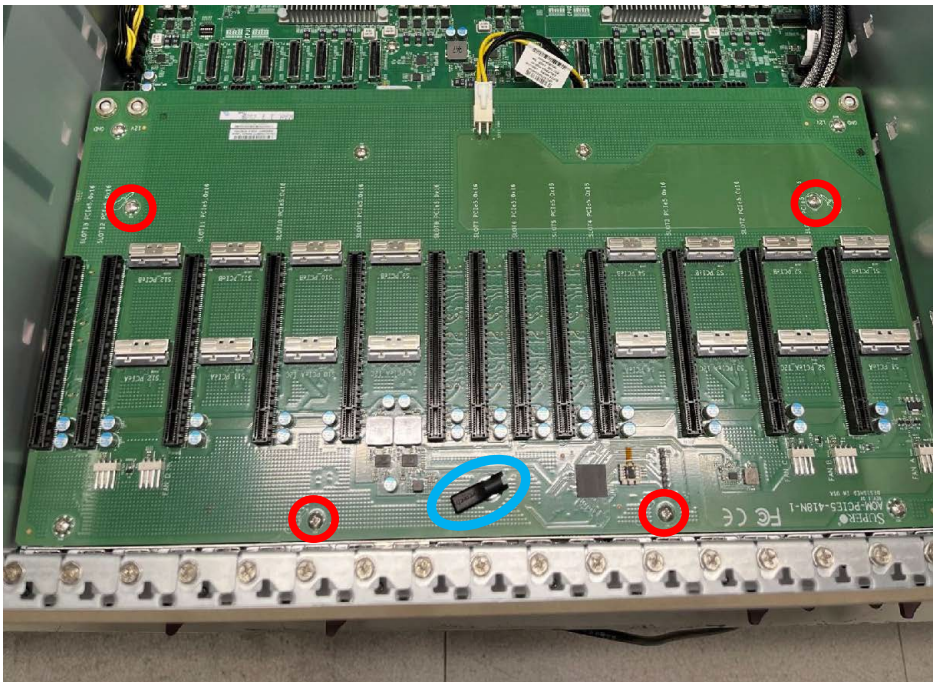

3. Unplug the cables connected to the bottom of the card and remove the card from the system.

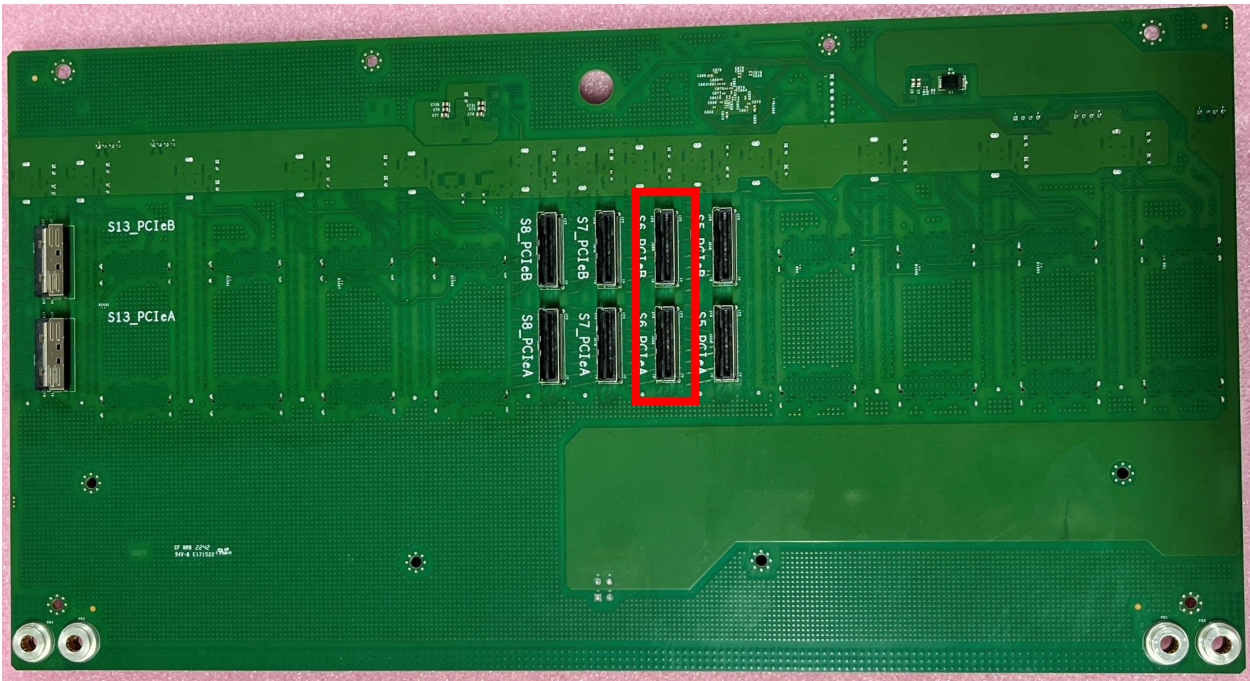

4. Remove the Expansion Card from the bracket by removing the 6 screws (circled in red)

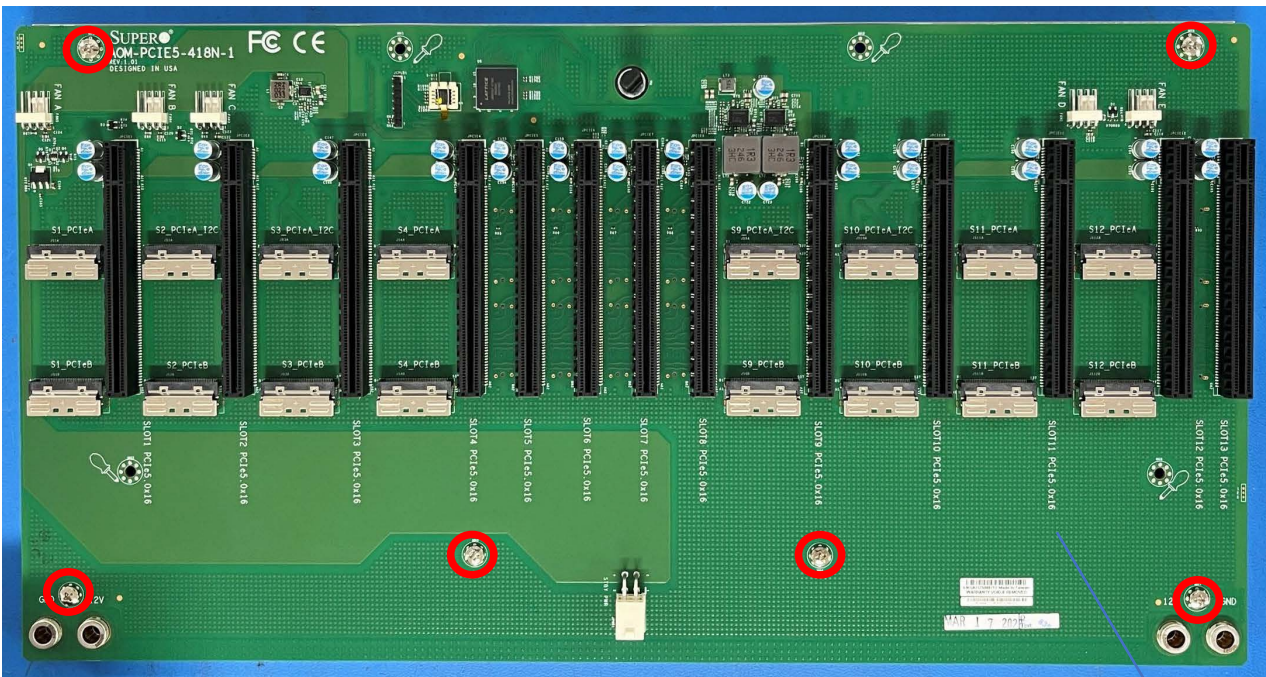

No.	Description
8.1	PCIe Expansion daughterboard

8.1

9. Removing Processor

1. Removing the PHM (Processor Heatsink Module) from the motherboard, first shut down the system and unplug the AC power cord from all power supplies
2. Use a T30-bit screwdriver to loosen the six screws on the heatsink in the sequence of 6,5,4,3,2,1 as shown in the picture below:

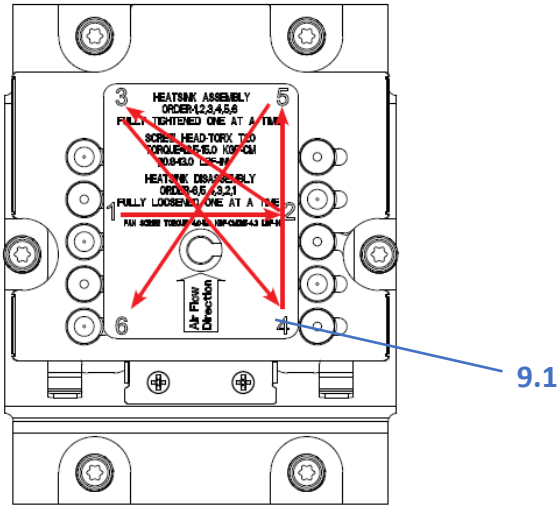

3. Once the screws have been removed, lift the heatsink module off the socket.

4. Unscrew the three screws holding the force frame in place and lift the force frame to the vertical position.

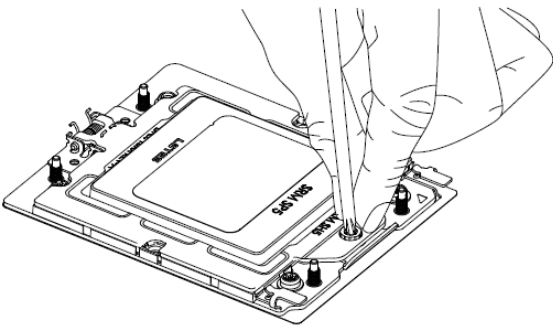

5. Gently remove the processor from the socket.

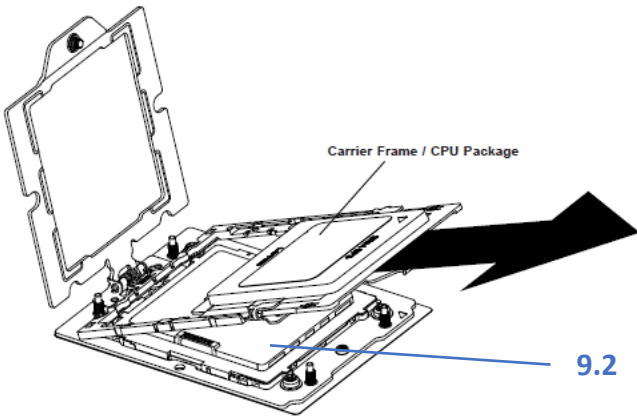

Note: Please handle the processor with care to avoid damaging it or its pins

No.	Description
9.1	Heat Sink
9.2	Processor

10. Removing DIMM

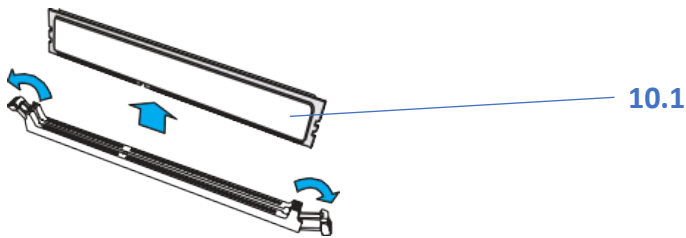

1. Hand press both release tabs on the ends of the DIMM module to unlock it
2. Once the DIMM module is loose, remove it from the memory slot

No.	Description
10.1	DIMM

11. Removing the M.2 from the Motherboard

1. Locate the M.2 on the motherboard at the J7 connector and press down on the clip holding the M.2 in place.
2. Gently pull the M.2 out of the socket.

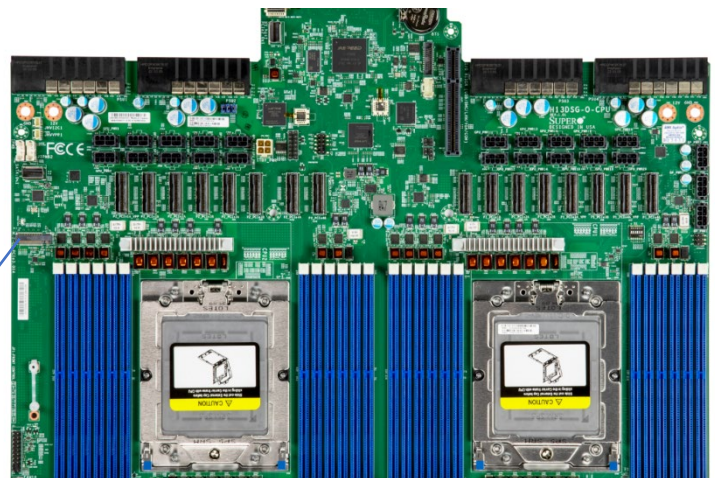
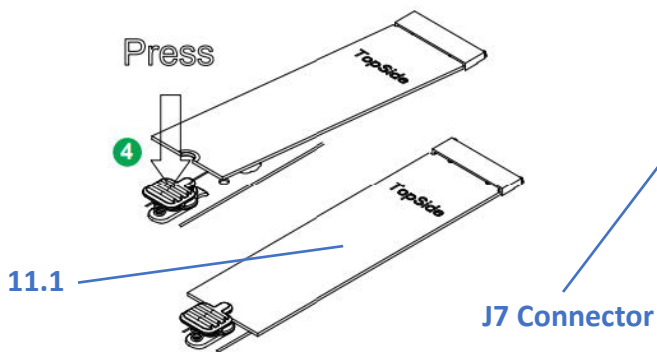

No.	Description
11.1	M.2

12. Removing Motherboard

1. Unscrew the screws (circled in red) on the motherboard and lift the motherboard out of the chassis.
2. Push aside the small clamp that covers the edge of the battery. When the battery is released, lift it out of the holder.

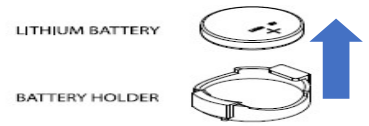
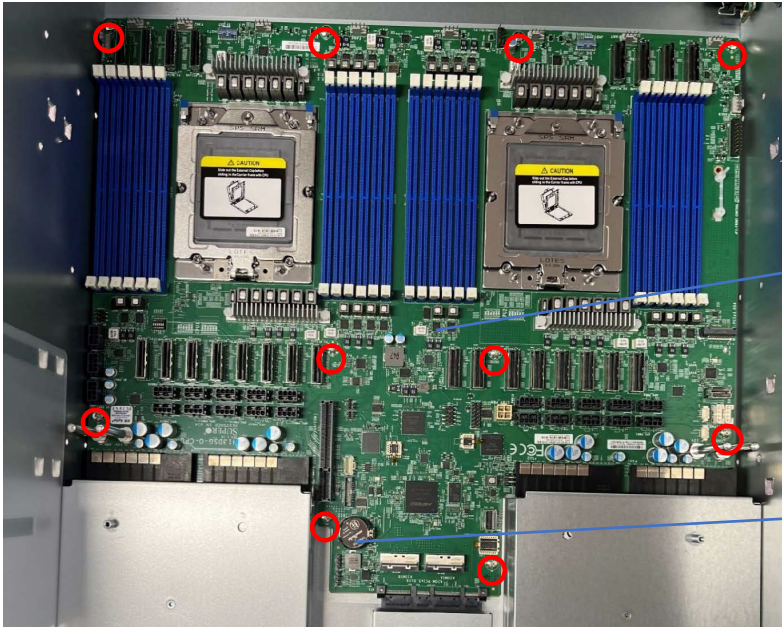

No.	Description
12.1	Motherboard
12.2	Battery

13. Removing Control Panel

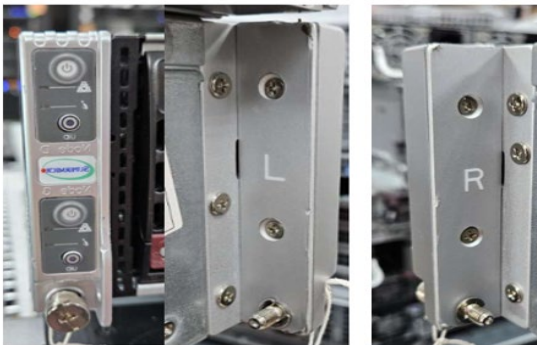

Remove control panel screw (R and L) from the chassis.



13.1

13.2

Remove basket screw and hand screw (R and L) from control panel and used hand remove basket mylar.

No.	Description
13.1	Control Panel Cover L & R
13.2	MYLAR_L & R

When the all the steps are complete, the chassis enclosure can be recycled.