

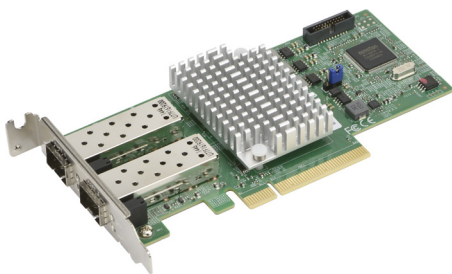

AOC-S25G-b2S



User's Guide

Revision 1.0a

The information in this User's Guide has been carefully reviewed and is believed to be accurate. The vendor assumes no responsibility for any inaccuracies that may be contained in this document, and makes no commitment to update or to keep current the information in this user's guide, or to notify any person or organization of the updates. **Please Note: For the most up-to-date version of this user's guide, please see our Website at www.supermicro.com.**

Super Micro Computer, Inc. ("Supermicro") reserves the right to make changes to the product described in this user's guide at any time and without notice. This product, including software and documentation, is the property of Supermicro and/or its licensors, and is supplied only under a license. Any use or reproduction of this product is not allowed, except as expressly permitted by the terms of said license.

IN NO EVENT WILL SUPER MICRO COMPUTER, INC. BE LIABLE FOR DIRECT, INDIRECT, SPECIAL, INCIDENTAL, SPECULATIVE OR CONSEQUENTIAL DAMAGES ARISING FROM THE USE OR INABILITY TO USE THIS PRODUCT OR DOCUMENTATION, EVEN IF ADVISED OF THE POSSIBILITY OF SUCH DAMAGES. IN PARTICULAR, SUPER MICRO COMPUTER, INC. SHALL NOT HAVE LIABILITY FOR ANY HARDWARE, SOFTWARE, OR DATA STORED OR USED WITH THE PRODUCT, INCLUDING THE COSTS OF REPAIRING, REPLACING, INTEGRATING, INSTALLING OR RECOVERING SUCH HARDWARE, SOFTWARE, OR DATA.

Any disputes arising between the manufacturer and the customer shall be governed by the laws of Santa Clara County in the State of California, USA. The State of California, County of Santa Clara shall be the exclusive venue for the resolution of any such disputes. Supermicro's total liability for all claims will not exceed the price paid for the hardware product.

FCC Statement: This equipment has been tested and found to comply with the limits for a Class A digital device pursuant to Part 15 of the FCC Rules. These limits are designed to provide reasonable protection against harmful interference when the equipment is operated in a commercial environment. This equipment generates, uses, and can radiate radio frequency energy and, if not installed and used in accordance with the manufacturer's instruction manual, may cause harmful interference with radio communications. Operation of this equipment in a residential area is likely to cause harmful interference, in which case you will be required to correct the interference at your own expense.

California Best Management Practices Regulations for Perchlorate Materials: This Perchlorate warning applies only to products containing CR (Manganese Dioxide) Lithium coin cells. "Perchlorate Material-special handling may apply. See www.dtsc.ca.gov/hazardouswaste/perchlorate".

WARNING: Handling of lead solder materials used in this product may expose you to lead, a chemical known to the State of California to cause birth defects and other reproductive harm.

User's Guide Revision 1.0a

Release Date: December 20, 2017

Unless you request and receive written permission from Super Micro Computer, Inc., you may not copy any part of this document.

Information in this document is subject to change without notice. Other products and companies referred to herein are trademarks or registered trademarks of their respective companies or mark holders.

Copyright © 2016 by Super Micro Computer, Inc.
All rights reserved.

Printed in the United States of America

Preface

About this User's Guide

This user's guide is written for system integrators, IT professionals, and knowledgeable end users. It provides information for the installation and use of the AOC-S25G-b2S add-on card.

An Important Note to the User

All graphic images and layout drawings shown in this user's guide are based upon the latest PCB revision available at the time of publishing of this user's guide. The add-on card you have received may or may not look exactly the same as the graphics shown in this user's guide.

Returning Merchandise for Service

A receipt or copy of your invoice marked with the date of purchase is required before any warranty service will be rendered. You can obtain service by calling your vendor for a Returned Merchandise Authorization (RMA) number. When returning to the manufacturer, the RMA number should be prominently displayed on the outside of the shipping carton and mailed prepaid or hand-carried. Shipping and handling charges will be applied for all orders that must be mailed when service is complete.

For faster service, RMA authorizations may be requested online (<http://www.supermicro.com/support/rma/>).

This warranty only covers normal consumer use and does not cover damages incurred in shipping or from failure due to the alteration, misuse, abuse or improper maintenance of products.

During the warranty period, contact your distributor first for any product problems.

Conventions Used in the User's Guide

Pay special attention to the following symbols for proper system installation:

Warning: Important information given to ensure proper system installation and to avoid possible damage done to the components or injury to yourself.



Note: Additional information given for proper system setup.

Important Links

For your system to work properly, please follow the links below to download all necessary drivers/utilities and the user's manual for your server.

- Supermicro product manuals: <http://www.supermicro.com/support/manuals/>
- Product drivers and utilities: <ftp://ftp.supermicro.com>
- Product safety info: http://www.supermicro.com/about/policies/safety_information.cfm
- If you have any questions, please contact our support team at: support@supermicro.com

This manual may be periodically updated without notice. Please check the Supermicro website for possible updates to the manual revision level.

Contacting Supermicro

Headquarters

Address: Super Micro Computer, Inc.
980 Rock Ave.
San Jose, CA 95131 U.S.A.

Tel: +1 (408) 503-8000

Fax: +1 (408) 503-8008

Email: marketing@supermicro.com (General Information)
support@supermicro.com (Technical Support)

Web Site: www.supermicro.com

Europe

Address: Super Micro Computer B.V.
Het Sterrenbeeld 28, 5215 ML
's-Hertogenbosch, The Netherlands

Tel: +31 (0) 73-6400390

Fax: +31 (0) 73-6416525

Email: sales@supermicro.nl (General Information)
support@supermicro.nl (Technical Support)
rma@supermicro.nl (Customer Support)

Web Site: www.supermicro.nl

Asia-Pacific

Address: Super Micro Computer, Inc.
3F, No. 150, Jian 1st Rd.
Zhonghe Dist., New Taipei City 235
Taiwan (R.O.C)

Tel: +886-(2) 8226-3990

Fax: +886-(2) 8226-3992

Email: support@supermicro.com.tw

Web Site: www.supermicro.com.tw

Table of Contents

Preface

Chapter 1 Introduction

1-1	Overview	1-1
1-2	About this Add-on Card.....	1-1
1-3	Key Features.....	1-1
1-4	Supermicro Motherboard Support.....	1-2

Chapter 2 Hardware Components

2-1	Add-On Card Image and Layout.....	2-1
2-2	Major Onboard Components.....	2-1
2-3	SFP28 Ethernet Connections.....	2-2
	SFP28 (LAN1/LAN2) Connectors.....	2-2
	SFP28 (LAN1/LAN2) Link/Activity LED Indicators.....	2-2
2-4	NC-SI Header & PCI-E 3.0 x8 Connector	2-3
	NC-SI Header.....	2-3
	PCI-E 3.0 x8 Connector.....	2-3
	3.3V Standby Power Enable.....	2-4
2-5	Jumper Settings	2-4
	Explanation of Jumpers	2-4

Chapter 3 Installation

3-1	Static-Sensitive Devices.....	3-1
	Precautions	3-1
3-2	Before Installation	3-2
3-3	Installing the Add-on Card	3-2
3-4	Installing Drivers (for Broadcom®BCM57414).....	3-3

Chapter 1

Introduction

1-1 Overview

Congratulations on purchasing your add-on card from an acknowledged leader in the industry. Supermicro products are designed with the utmost attention to detail to provide you with the highest standards in quality and performance.

1-2 About this Add-on Card

The Supermicro AOC-S25G-b2S is the most advanced Network-Controller Sideband Interface (NC-SI) Ethernet LAN card in the market today. With the Broadcom® BCMBCM57414 Controller and dual optical transceiver (SFP28) ports built-in, this add-on card provides unprecedented network interface connectivity with a speed of up to 25Gbps.

Featuring Asset Management for Supermicro system and server platforms, this add-on card supports the TruFlow™ Technology, SR-IOV, multi-queueing, stateless offloads, network overlay, NIC partitioning, IEEE 1588 and RDMA over Converged Ethernet (RoCE). The AOC-S25G-b2S offers high-performance connectivity and superb remote sideband manageability to meet the growing needs of high-end computing platforms. For more information regarding product support or updates, please refer to our website at <http://www.supermicro.com/products/accessories/addon/AOC-S25G-b2S.cfm>.

1-3 Key Features

The key features of this add-on card include the following:

- Standard PCI-E Gen3 x8 lanes host interface
- Low profile, standard short-length form factor
- TruFlow™ (Flow-processing engine integrated to reduce CPU overheads)
- SR-IOV with up to 128 VFs
- Low Latency (TX/RX combined latency = 1.5 us)

- Multi-Queue support (NDIS, VMQ, and Net-Queue)
- Stateless Offloads
- RoCE (RDMA over Converged Ethernet)
- Network overlay: VXLAN and NVGR
- NPAR (NIC partitioning)
- IEEE 1588
- Asset Management (for Supermicro systems only)
- Low power (less than 5W typically)
- RoSH support
- Cable support: copper cables, fiber cables, optic cables with optional transceivers
- Dimensions 2.7" (W) x 5.9" (L) (68.58cm (H) x 149.86cm (L))

1-4 Supermicro Motherboard Support

This add-on card supports the following motherboards:

- X10SRD-F
- X10SDV-TLN4F
- X10SLA-F
- X10SLX-F
- X10SRA-F
- X10SRG-F
- X10SRH-CF
- X10SRH-CLN4F
- X10SRi-F

- X10SRL-F
- X10SRW-F
- X10DAi
- X10DAC
- X10DAX
- X10DAL-i
- X10DRC-T4+
- X10DRC-LN4+
- X10DRI-T4+
- X10DRI-LN4+
- X10DRT-P
- X10DRD-iNTP
- X10DRD-LTP
- X10DRFF-C
- X10DRFR-T
- X10DRG-Q
- X10DRH-C
- X10DRH-iT
- X10DRI-T
- X10DRL-CT
- X10DRL-i
- X10DRT-L

- X10DRT-LIBQ
- X10DRT-LIBF
- X10DRU-i+
- X10DRW-E
- X10DRW-N
- X10DRX
- X10DRD-iNT
- X10DRD-L

Chapter 2

Hardware Components

2-1 Add-On Card Image and Layout

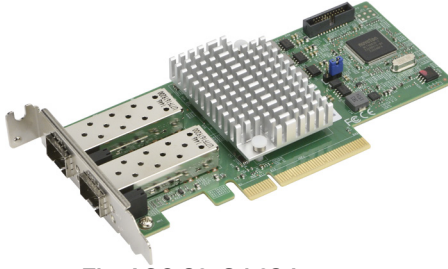

The AOC-S25G-b2S Image

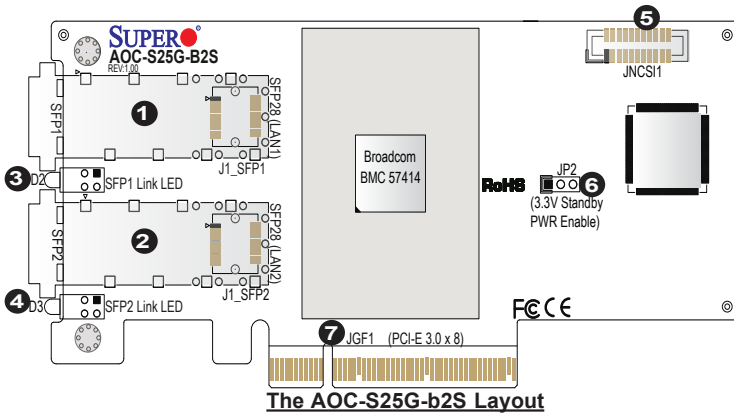

The AOC-S25G-b2S Layout

2-2 Major Onboard Components

AOC-S25G-b2S Major Components					
No	Component Name	No	Component Name	No	Component Name
1	SFP1: SFP28 (LAN1)	4	LAN2 Link LED	7	JGF1: PCI-E 3.0 x8
2	SFP2: SFP28 (LAN2)	5	JNCSI1: NCSI header		
3	LAN1 Link LED	6	JP2: Stby PWR Enable		

2-3 SFP28 Ethernet Connections

SFP28 (LAN1/LAN2) Connectors

Two small form-factor pluggable (SFP28) optical transceiver connectors (SFP1/SFP2) are located on the add-on card. These SFP 28 ports provide Ethernet 25GbE/10GbE network connections. See the layout below for the locations.

SFP28 (LAN1/LAN2) Link/Activity LED Indicators

Two LAN Link/Activity LED indicators are located at D2 and D3 on the add-on card. D2 is used for the SFP28 LAN1 connector, and D3, for SFP28 LAN2 connector. See the table below for the LED states.

LAN Port Activity LED Indicators D2/D3 Assignment/State	
LED	LAN Port Assigned
D2	SFP LAN1 Active
D3	SFP LAN2 Active
Green	SFP LAN Port Active

LAN Port Link LEDs (D2/D3) LED State	
LED Color	Definition
Amber	10 Gbps
Green	25 Gbps

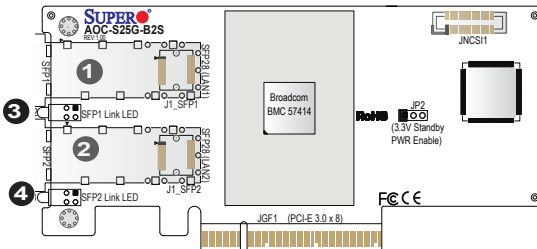

1. SF28 LAN1
2. SF28 LAN2
3. D2: SF28 LAN1 LED
4. D3: SF28 LAN2 LED

2-4 NC-SI Header & PCI-E 3.0 x8 Connector

NC-SI Header

A Network-Controller Sideband Interface (NC-SI) header is located at JNCSI1 on the add-on card. Connect an appropriate cable from this header to a motherboard to provide the out-of-band (sideband) connection between the onboard Baseboard Management Controller (BMC) and a Network Interface Controller (NIC) for remote management. For the network sideband interface to work properly, you will need to use a motherboard that supports NC-SI and also need to have a special cable. Please contact Supermicro at www.supermicro.com to purchase the cable for this header. See the layout below for the location of the JNCSI1 header.

PCI-E 3.0 x8 Connector

A PCI-E 3.0 x8 connector is located at JGF1 on the add-on card. Insert this connector into a PCI-E 3.0 x 8 slot on a motherboard to use this add-on card. See the layout below for the location.

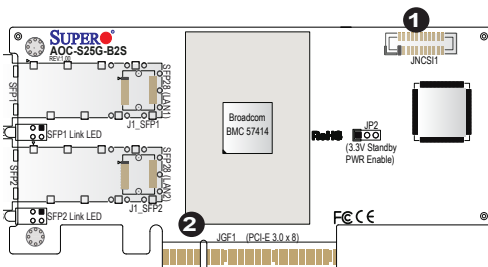

1. NC-SI Header
2. PCI-E 3.0 x8 Connector

2-5 Jumper Settings

Explanation of Jumpers

To modify the operation of the motherboard, jumpers can be used to choose between optional settings. Jumpers create shorts between two pins to change the function of the connector. Pin 1 is identified with a square solder pad on the printed circuit board. See the motherboard layout pages for jumper locations.

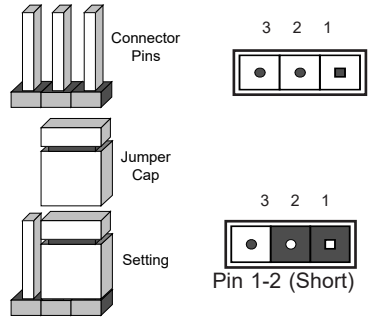

3.3V Standby Power Enable

The 3.3V Standby Power Enable jumper is located at JP2 on the add-on card. Close Pins 1 & 2 to enable 3.3V Standby Power support. The default setting is **Disabled**.

3.3V Standby PWR Enable Jumper Settings	
Jumper setting	Definition
Pins: 1-2	Enabled
Pins: 2-3	Disabled (default)

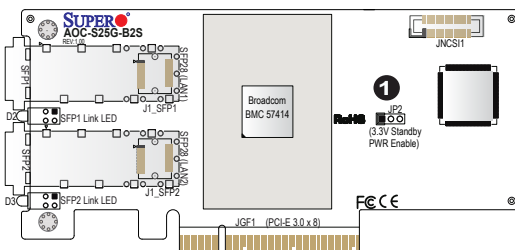

1. Standby PWR Enable

Chapter 3

Installation



Note: Your system came with the AOC-S25G-b2S add-on card to be used as a part of an integrated solution. We do not recommend that any part of your system components be removed and re-installed. However, if you do need to remove or re-install a system component, including this add-on card, please follow the instructions below to ensure proper system setup. Also, be sure to remove the power cord first before adding, removing or changing any hardware components to avoid damaging the system or components.

3-1 Static-Sensitive Devices

Electrostatic Discharge (ESD) can damage electronic components. To avoid damaging your add-on card, it is important to handle it very carefully. The following measures are generally sufficient to protect your equipment from ESD.

Precautions

- Use a grounded wrist strap designed to prevent static discharge.
- Touch a grounded metal object before removing the add-on card from the antistatic bag.
- Handle the add-on card by its edges only; do not touch its components, or peripheral chips.
- Put the add-on card back into the antistatic bags when not in use.
- For grounding purposes, make sure that your system chassis provides excellent conductivity between the power supply, the case, the mounting fasteners and the add-on card.

3-2 Before Installation

To install the add-on card properly, be sure to follow the instructions below.

1. Power down the system.
2. Remove the power cord from the wall socket.
3. Use industry-standard anti-static equipment (such as gloves or wrist strap) and follow the instructions listed on Page 3-1 to avoid damage caused by ESD.
4. Familiarize yourself with the server, motherboard, and/or chassis documentation.
5. Confirm that your operating system includes the latest updates and hotfixes.

3-3 Installing the Add-on Card

Follow the steps below to install the add-on card into your system.

1. Remove the server cover and, if necessary, set aside any screws for later use.
2. Remove the add-on card slot cover. If the case requires a screw, place the screw aside for later use.
3. Position the add-on card in the slot directly over the connector on the motherboard, and gently push down on both sides of the card until it slides into the PCI connector.
4. Secure the add-on card/motherboard to the chassis. If required, use the screw that you previously removed.
5. Attach any necessary external cables to the add-on card.
6. Replace the chassis cover.
7. Plug the power cord into the wall socket, and power up the system.

3-4 Installing Drivers (for Broadcom®BCM57414)

To install both drivers and firmware for the AOC-S25G-b2S add-on card for either Linux and Windows, please follow the instructions below.

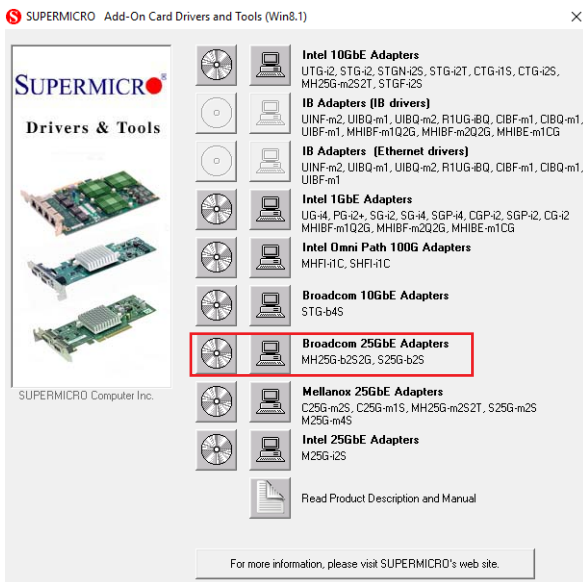

Before Installing the Drivers for the Linux Operating System Only

Infiniband-diags is a set of utilities designed to help configure, debug, and maintain infiniband fabrics. Installing them from the Linux library is necessary prior to driver installation. To do so, please first download the following libraries:

```
yum -y install libibverbs* infiniband-diags perftest qperf
librdmacm-utils
```

```
yum -y install groupinstall "InfiniBand Support"
```

Installing 25G Drivers for the Linux Operating System

Follow the steps below to install the drivers on the Linux operating system:

1. Download the Linux driver package file: nextxtreme-bnxt_en-<ver>.tar.gz.



Note: This driver can be found on either the SuperMicro website, or by going to the Linux_Driver directory from the FTP site (<ftp://ftp.supermicro>).

com/Networking_Drivers) or CDR-NIC LAN driver CD by going to the following directory: Broadcom > 25G > Linux > Linux_Driver.

2. Install the driver by entering the following commands

```
tar xvzf netextreme-bnxt_en-<ver>.tar.gz
cd netextreme-bnxt_en-<ver>
make build
make install
```

RDMA over Converged Ethernet (RoCE) is a network protocol that allows remote direct memory access (RDMA) over an Ethernet network. This feature is optional, but if you would like to install with RoCE, please follow the additional steps below:

1. Download the Linux driver package file: libbnxt_re-<ver>.tar.gz.



Note: This driver can be found on either the SuperMicro website, or by going to the Linux_RoCE_Lib directory from the FTP site (ftp://ftp.supermicro.com/Networking_Drivers) or CDR-NIC LAN driver CD by going to the following directory: Broadcom > 25G > Linux > Linux_RoCE_Lib.

2. Install the library by entering the following commands:

```
tar xvzf libbnxt_re-<ver>.tar.gz
cd libbnxt_re-<ver>
./configure
make
make install
cp bnxt_re.driver/etc/libibverbs.d
echo "/usr/local/lib">>etc/ld.so.conf
ldconfig -v
```

Installing 25G Drivers for the Windows Operating System

Follow the steps below to install the drivers on the Windows operating system:

1. From the FTP site or CDR-NIC LAN driver CD, go to the following directory: Broadcom > 25G > Windows.
2. Choose the desired Windows driver package folder.
3. As the drivers are in .inf format, you can install the driver from the Device Manager.

(Disclaimer Continued)

The products sold by Supermicro are not intended for and will not be used in life support systems, medical equipment, nuclear facilities or systems, aircraft, aircraft devices, aircraft/emergency communication devices or other critical systems whose failure to perform be reasonably expected to result in significant injury or loss of life or catastrophic property damage. Accordingly, Supermicro disclaims any and all liability, and should buyer use or sell such products for use in such ultra-hazardous applications, it does so entirely at its own risk. Furthermore, buyer agrees to fully indemnify, defend and hold Supermicro harmless for and against any and all claims, demands, actions, litigation, and proceedings of any kind arising out of or related to such ultra-hazardous use or sale.