

SUPER●

SUPER S2DG2
SUPER S2DGU
SUPER S2DGE
SUPER S2DGR

USER'S AND BIOS MANUAL

Revision 1.4

The information in this User's Manual has been carefully reviewed and is believed to be accurate. The vendor assumes no responsibility for any inaccuracies that may be contained in this document, makes no commitment to update or to keep current the information in this manual, or to notify any person or organization of the updates. **Please Note: For the most up-to-date version of this manual, please see our web site at www.supermicro.com.**

SUPERMICRO COMPUTER reserves the right to make changes to the product described in this manual at any time and without notice. This product, including software, if any, and documentation may not, in whole or in part, be copied, photocopied, reproduced, translated or reduced to any medium or machine without prior written consent.

IN NO EVENT WILL SUPERMICRO COMPUTER BE LIABLE FOR DIRECT, INDIRECT, SPECIAL, INCIDENTAL OR CONSEQUENTIAL DAMAGES ARISING FROM THE USE OR INABILITY TO USE THIS PRODUCT OR DOCUMENTATION, EVEN IF ADVISED OF THE POSSIBILITY OF SUCH DAMAGES. IN PARTICULAR, THE VENDOR SHALL NOT HAVE LIABILITY FOR ANY HARDWARE, SOFTWARE OR DATA STORED OR USED WITH THE PRODUCT, INCLUDING THE COSTS OF THE REPAIRING, REPLACING, INTEGRATING, INSTALLING OR RECOVERING SUCH HARDWARE, SOFTWARE OR DATA.

Unless you request and receive written permission from SUPERMICRO COMPUTER, you may not copy any part of this document.

Information in this document is subject to change without notice. Other products and companies referred to herein are trademarks or registered trademarks of their respective companies or mark holders.

Copyright © 1999 by SUPERMICRO COMPUTER INC.
All rights reserved.

Printed in the United States of America.

Preface

About This Manual

This manual is written for system houses, PC technicians and knowledgeable PC end users. It provides information for the installation and use of the SUPER S2DG2/S2DGU/S2DGE/S2DGR motherboard. The SUPER S2DG2/S2DGU/S2DGE/S2DGR supports Pentium II and III Xeon processors.

The Pentium II/III Xeon processor with the Dual Independent Bus Architecture is based on the "Slot 2" infrastructure, which will provide the headroom for future high-performance processors.

Manual Organization

Chapter 1, Introduction, describes the features, specifications and performance of the SUPER S2DG2/S2DGU/S2DGE/S2DGR system board and provides detailed information about the chipset.

Refer to Chapter 2, Installation, for instructions on how to install the Pentium II/III Xeon processor, the retention mechanism and the heat sink support. This chapter also provides you with instructions for handling static-sensitive devices. Read this chapter when you want to install DIMM modules and to mount the system board in the chassis. Also refer to this chapter to connect the floppy and hard disk drives, IDE interfaces, parallel port and serial ports as well as the cables for the power supply, reset cable, Keylock/Power LED, speaker and keyboard.

If you encounter any problems, see Chapter 3, Troubleshooting, which describes troubleshooting procedures for the video, the memory and the setup configuration stored in memory. For quick reference, a general FAQ [Frequently Asked Questions] section is provided. Instructions are also included for technical support procedures, returning merchandise for service and for BIOS upgrades using our BBS#.

See Chapter 4 for configuration data and BIOS features.

Chapter 5 has information on running setup and includes the default settings for Standard Setup, Advanced Setup, Chipset Function, Power Management, PCI/PnP Setup and Peripheral Setup.

Appendix A offers information on BIOS error beep codes and messages.

Appendix B shows post diagnostic error messages.

Table of Contents

Preface

| | |
|-----------------------------------|------|
| About This Manual | iii |
| Manual Organization | iii |
| Jumper Quick Reference | viii |
| Front Control Panel Headers | ix |

Chapter 1: Introduction

| | |
|---|------|
| 1-1 Overview | 1-1 |
| SUPER S2DG2 Image | 1-2 |
| SUPER S2DG2 Motherboard Layout | 1-3 |
| SUPER S2DGU Image | 1-4 |
| SUPER S2DGU Motherboard Layout | 1-5 |
| SUPER S2DGE Image | 1-6 |
| SUPER S2DGE Motherboard Layout | 1-7 |
| SUPER S2DGR Image | 1-8 |
| SUPER S2DGR Motherboard Layout | 1-9 |
| 440GX AGP Chipset: System Block Diagram | 1-10 |
| Motherboard Features | 1-11 |
| 1-2 Chipset Overview | 1-13 |
| 1-3 Slot 2 Architecture | 1-13 |
| 1-4 PC Health Monitoring | 1-13 |
| 1-5 ACPI/PC 98 Features | 1-16 |
| 1-6 Power Supply Requirements | 1-17 |
| 1-7 Super I/O | 1-18 |
| 1-8 AIC 7890 SCSI Controller | 1-19 |
| 1-9 AIC 7895 SCSI Controller | 1-19 |
| 1-10 AIC 7896 SCSI Controller | 1-20 |

Chapter 2: Installation

| | |
|--|-----|
| 2-1 Static-Sensitive Devices | 2-1 |
| Precautions | 2-1 |
| Unpacking | 2-1 |
| 2-2 Pentium II and III Xeon Processor Installation | 2-1 |
| Removing the Pentium II/III Xeon Processor | 2-2 |
| 2-3 Explanation and Diagram of Jumper/Connector | 2-4 |
| 2-4 Changing the CPU Speed | 2-4 |
| 2-5 Mounting the Motherboard in the Chassis | 2-5 |

| | | |
|-----|---|------|
| 2-6 | Connecting Cables | 2-5 |
| | Power Supply Connectors | 2-5 |
| | Secondary Power Connector | 2-5 |
| | Infrared Connector | 2-5 |
| | PW_ON Connector | 2-6 |
| | Reset Connector | 2-6 |
| | Hard Drive LED | 2-6 |
| | Keylock/Power LED Connector | 2-6 |
| | Speaker Connector | 2-7 |
| | Power Save State Select | 2-7 |
| | ATX PS/2 Keyboard and Mouse Ports | 2-7 |
| | Universal Serial Bus | 2-7 |
| | ATX Serial Ports | 2-8 |
| | CMOS Clear | 2-8 |
| | External Battery | 2-8 |
| | Wake-On-LAN | 2-8 |
| | Fan Connectors | 2-8 |
| | Chassis Intrusion | 2-9 |
| | SLED Indicator | 2-9 |
| 2-7 | Installing DIMMs | 2-9 |
| | DIMM Installation | 2-9 |
| 2-8 | Connecting the Parallel Port, FDD and HDD | 2-10 |
| | Parallel Port Connector | 2-11 |
| | Floppy Connector | 2-11 |
| | IDE Interfaces | 2-11 |
| | SCSI Connectors | 2-12 |
| | Ultra2 LVD/SE SCSI Connector | 2-13 |
| | AGP Port | 2-14 |

Chapter 3: Troubleshooting

| | | |
|-----|---|-----|
| 3-1 | Troubleshooting Procedures | 3-1 |
| | Before Power On | 3-1 |
| | Troubleshooting Flowchart | 3-1 |
| | No Power | 3-2 |
| | No Video | 3-2 |
| | Memory Errors | 3-2 |
| | Losing the System's Setup Configuration | 3-3 |
| 3-2 | Technical Support Procedures | 3-3 |

| | | |
|-----|---|-----|
| 3-3 | Frequently Asked Questions | 3-4 |
| 3-4 | Returning Merchandise for Service | 3-7 |

Chapter 4: AMIBIOS

| | | |
|-----|---|-----|
| 4-1 | Introduction | 4-1 |
| 4-2 | BIOS Features | 4-2 |
| | BIOS Configuration Summary Screen | 4-3 |
| | AMIBIOS Setup | 4-3 |

Chapter 5: Running Setup

| | | |
|-----|--|------|
| 5-1 | Setup | 5-1 |
| | 5-1-1 Standard CMOS Setup | 5-1 |
| | 5-1-2 Advanced CMOS Setup | 5-3 |
| | 5-1-3 Advanced Chipset Setup | 5-7 |
| | 5-1-4 Power Management Setup | 5-13 |
| | 5-1-5 PCI/PnP Setup | 5-15 |
| | 5-1-6 Peripheral Setup | 5-17 |
| 5-2 | Auto Detect Hard Disks | 5-19 |
| 5-3 | Change User/Supervisor Password | 5-20 |
| 5-4 | Change Language Setting | 5-20 |
| 5-5 | Default Settings | 5-21 |
| | 5-4-1 Auto Configuration with Optimal Settings | 5-21 |
| | 5-4-2 Auto Configuration with Fail-Safe Settings | 5-21 |

Appendices:

| | | |
|-------------|--|-----|
| Appendix A: | BIOS Error Beep Codes and Messages | A-1 |
| Appendix B: | AMIBIOS Post Diagnostic Error Messages | B-1 |

Jumpers Quick Reference

| S2DG2/S2DGR | | | S2DGU/S2DGE* | | |
|--------------------|---|-------|--------------------|---|--|
| Jumpers | Function | Page | Jumpers | Function | |
| JB1, JB2, JB3, JB4 | CPU Core/Bus Ratio Selection | 2-4 | JB1, JB2, JB3, JB4 | CPU Core/Bus Ratio Selection | |
| JBT1 | CMOS Clear | 2-8 | JBT1 | CMOS Clear | |
| JP20 | Power Save State | 2-7 | JP20 | Power Save State | |
| BZ_ON | Overheat Alarm Enable | 1-5 | S-TERM | SCSI Termination (default on = terminated) | |
| JA5, JA6, JA7** | SCSI Termination (default on = terminated) | 1-3,9 | JOH | Overheat LED Header | |
| JOH | Overheat LED Header | 1-3,9 | BZ_ON | Overheat Alarm Enable | |
| J36 | Secondary Power Connector | 2-5 | J36 | Secondary Power Connector | |
| Connectors | Function | Page | Connectors | Function | |
| J17 | USB | 2-7 | J17 | USB | |
| J18 | USB | 2-7 | J18 | USB | |
| J19 | Parallel Port | 2-11 | J19 | Parallel Port | |
| J20 | COM 1 | 2-8 | J20 | COM 1 | |
| J21 | COM 2 | 2-8 | J21 | COM 2 | |
| J32 | ATX Power Connector | 2-5 | J32 | ATX Power Connector | |
| J34 | PS/2 KB and Mouse | 2-7 | J34 | PS/2 KB and Mouse | |
| JA1, JA2 (S2DG2) | Ultra2 LVD/SE SCSI | 2-13 | JA1 | Ultra2 LVD/SE SCSI | |
| JA1, JA2 (S2DGR) | UW SCSI | 2-12 | JA2 | UW SCSI | |
| JA3 | SCSI | 2-12 | JA4 | SCSI | |
| JBT2 | External Battery | 2-8 | JBT2 | External Battery | |
| JF1 | IDE Hard Drive LED | 2-6 | JF1 | IDE Hard Drive LED | |
| | Keylock | 2-6 | | Keylock | |
| | Speaker | 2-7 | | Speaker | |
| JF2 | IR Connector | 2-5 | JF2 | IR Connector | |
| | PW_ON | 2-6 | | PW_ON | |
| | Reset | 2-6 | | Reset | |
| JL1 | Chassis Intrusion | 2-9 | JL1 | Chassis Intrusion | |
| SLED | SCSI LED | 2-9 | SLED | SCSI LED | |
| JT1/JT1A | CPU 1 Fan | 2-8 | JT1/JT1A | CPU 1 Fan | |
| JT2/JT2A | CPU 2 Fan | 2-8 | JT2/JT2A | CPU 2 Fan | |
| JT3/JT3A | Thermal Control Fan | 2-8 | JT3/JT3A | Thermal Control Fan | |
| WOL | Wake-On-LAN | 2-8 | WOL | Wake-On-LAN | |

* SCSI jumpers and connectors do not apply to the S2DGE.

** S2DG2: Jumping JA5 terminates SCSI connector JA1.
 Jumping JA6 terminates SCSI connector JA3.
 Jumping JA7 terminates SCSI connector JA2.

S2DGR: Jumping JA5 terminates SCSI connectors JA1 and JA3.
 Jumping JA6 terminates SCSI connector JA2.
 (JA7 is not used for the S2DGR.)

Front Control Panel Headers

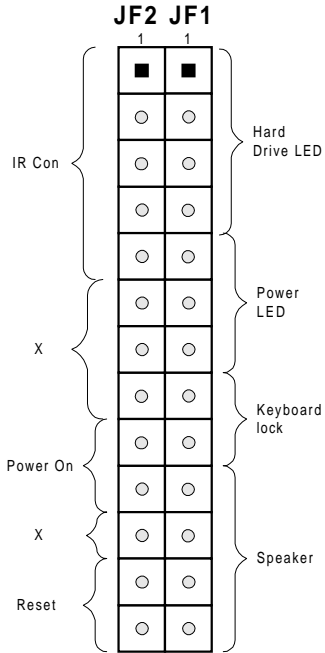

See pages 2-5 through 2-7 for pin definitions.

Notes

Chapter 1

Introduction

1-1 Overview

The SUPER S2DG2/S2DGU/S2DGE/S2DGR supports dual Pentium II Xeon™ and dual Pentium III Xeon processors. All four motherboards are based on Intel's 440GX chip set, which supports a 100 MHz system bus speed, an Accelerated Graphics Port (AGP), Wake-on-LAN™, SDRAM, concurrent PCI and a 33 MB/s Ultra DMA burst data transfer rate.

While all of the motherboards are the ATX form factor, the S2DG2, S2DGU and S2DGE have 5 PCI and 2 ISA slots (with one shared). The S2DGR has 4 PCI and 2 ISA slots (with one shared). All have an AGP port and can accommodate up to 2 GB unbuffered SDRAM or registered SDRAM memory in 4 168-pin DIMM sockets.

AGP reduces contention between the CPU and I/O devices by broadening the graphics bandwidth to memory. It delivers a maximum of 532 MB/s in the 2x transfer mode, which is quadruple the PCI speed!

Wake-On-LAN allows for the remote network management and configuration of the PC, even in off-hours when the PC is turned off. This reduces the complexity of managing the network.

Other features that maximize customer satisfaction and simplicity in managing the computer are its support for the PC 98-ready and the Advanced Configuration and Power Interface (ACPI) standards. With PC Health Monitoring, you can protect your system from problems before they even occur.

All motherboards include the following I/O: 2 EIDE ports, a floppy port, an ECP/EPP supported parallel port, PS/2 mouse and PS/2 keyboard ports, 2 serial ports, an infrared port and 2 USB ports. The S2DGR has an integrated onboard Adaptec 7895 dual UW SCSI controller. The dual channels enable a data transfer rate of 40 MB/s per channel and an optional RAID II port (ARO-1130CA/SA). The S2DG2 has the onboard Adaptec 7896 controller for Ultra2 LVD (Low Voltage Device) SCSI, which enables a data transfer rate of 80 MB/s per channel and an optional RAID III port (ARO-1130C). In addition, this motherboard has an onboard RAID port to support the Adaptec ARO-1130C RAIDport III card for increased I/O performance and fault tolerance. The S2DGU provides an onboard Adaptec 7890 Ultra2 LVD SCSI controller, which enables data transfer rates of up to 80 MB/s, and an optional RAID III port (ARO-1130C).

SUPER S2DG2

Figure 1-1. SUPER S2DG2 Motherboard Image



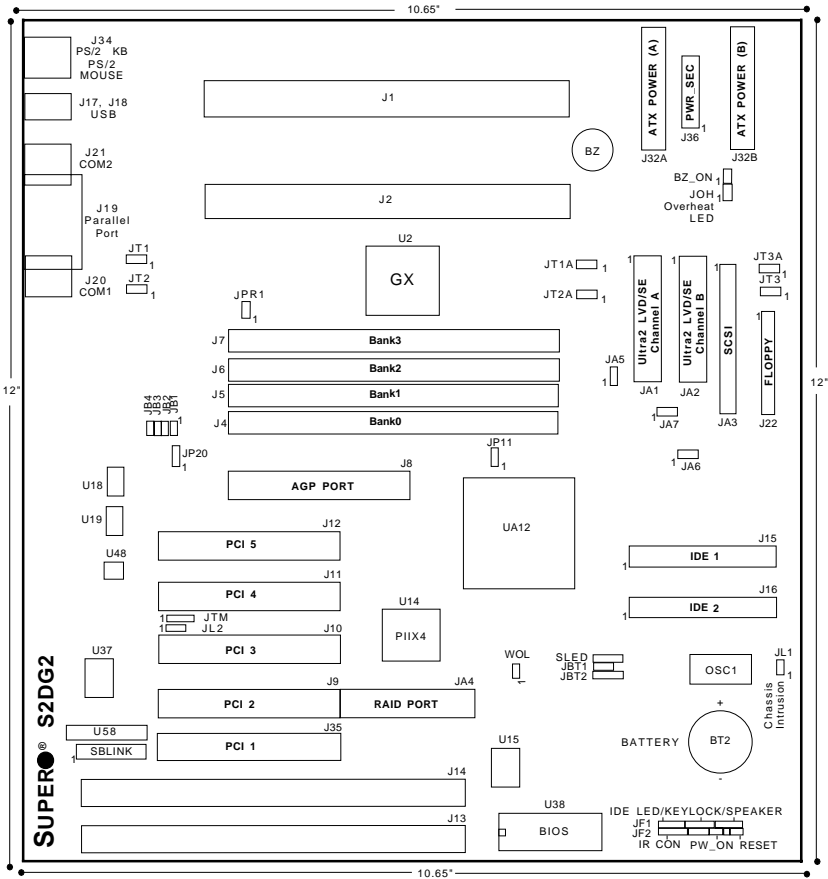

Manufacturer Settings

| | |
|-------|--|
| JBT1: | 1-2 (default) 2-3 CMOS Clear *To clear CMOS completely, disconnect the power source. |
| JL1: | OFF (default) ON (intrusion) |
| JP11: | 1-2 = 100 MHz 2-3 = 66 MHz |
| JP20: | 1-2 PIIX CTL PD State 2-3 BIOS CTL PD State (default) |
| WOL: | Wake-On-LAN |
| JA5: | SCSI Termination for JA1 |
| JA6: | SCSI Termination for JA3 |
| JA7: | SCSI Termination for JA2 |

CPU Core/Bus Ratio

| | JB1 | JB2 | JB3 | JB4 |
|------|-----|-----|-----|-----|
| x8 | ON | OFF | ON | ON |
| x3.5 | OFF | OFF | ON | ON |
| x4 | ON | ON | OFF | ON |
| x4.5 | OFF | ON | OFF | ON |
| x5 | ON | OFF | OFF | ON |
| x5.5 | OFF | OFF | OFF | ON |
| x6 | ON | ON | ON | OFF |
| x6.5 | OFF | ON | ON | OFF |
| x7 | ON | OFF | ON | OFF |
| x7.5 | OFF | OFF | ON | OFF |

Note: JA3 is optional.

Note: Some CPU Core/Bus ratios cannot be selected with jumpers for processors that have fixed ratios.

Note: To enable the overheat buzzer, place a jumper on BZ_ON.

Figure 1-2. SUPER S2DG2 Motherboard Layout

SUPER S2DGU

Figure 1-3. SUPER S2DGU Motherboard Image



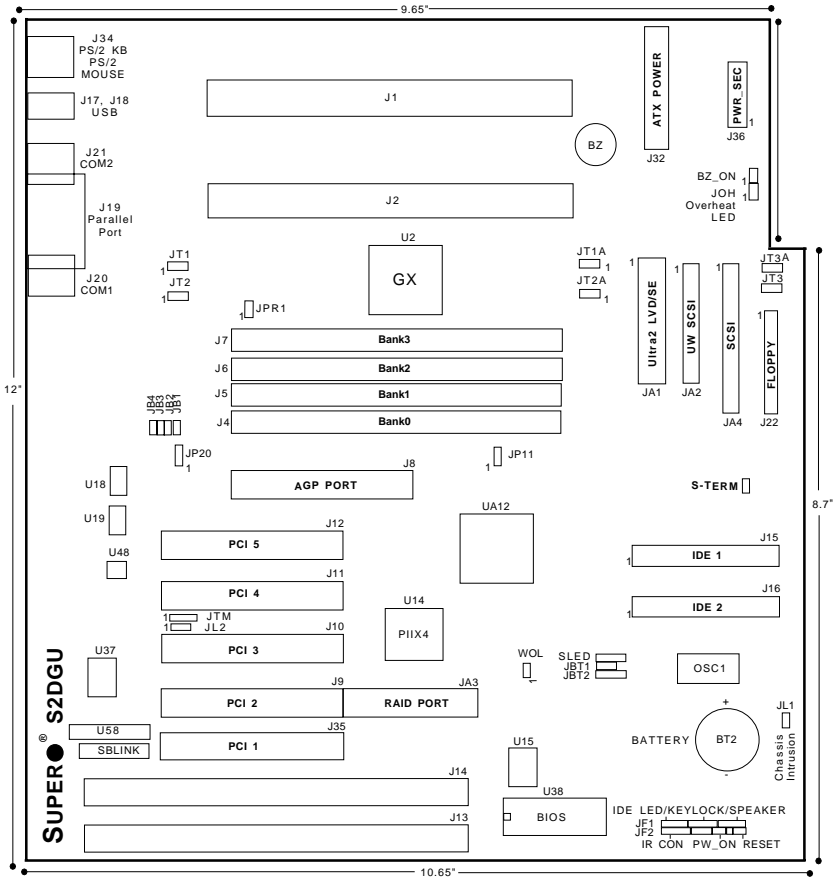

SUPER S2DGU

| Manufacturer Settings | |
|-----------------------|---|
| JBT1: | 1-2 (default) 2-3 CMOS Clear *To clear CMOS completely, disconnect the power source. |
| JL1: | OFF (default) ON (intrusion) |
| JP11: | 1-2 = 100 MHz 2-3 = 66 MHz |
| JP20: | 1-2 PIIIX CTL PD State 2-3 BIOS CTL PD State (default) |
| WOL: | Wake-On-LAN |
| S-TERM: | On: SCSI Termination Enable Off: Termination Disable |

| CPU Core/Bus Ratio | | | | |
|--------------------|-----|-----|-----|-----|
| | JB1 | JB2 | JB3 | JB4 |
| x3 | ON | OFF | ON | ON |
| x3.5 | OFF | OFF | ON | ON |
| x4 | ON | ON | OFF | ON |
| x4.5 | OFF | ON | OFF | ON |
| x5 | ON | OFF | OFF | ON |
| x5.5 | OFF | OFF | OFF | ON |
| x6 | ON | ON | ON | OFF |
| x6.5 | OFF | ON | ON | OFF |
| x7 | ON | OFF | ON | OFF |
| x7.5 | OFF | OFF | ON | OFF |

Note: JA3 is optional.

Note: Some CPU Core/Bus ratios cannot be selected with jumpers for processors that have fixed ratios.

Note: To enable the overheat buzzer, place a jumper on BZ_ON.

Figure 1-4. SUPER S2DGU Motherboard Layout

SUPER S2DGE

Figure 1-5. SUPER S2DGE Motherboard Image



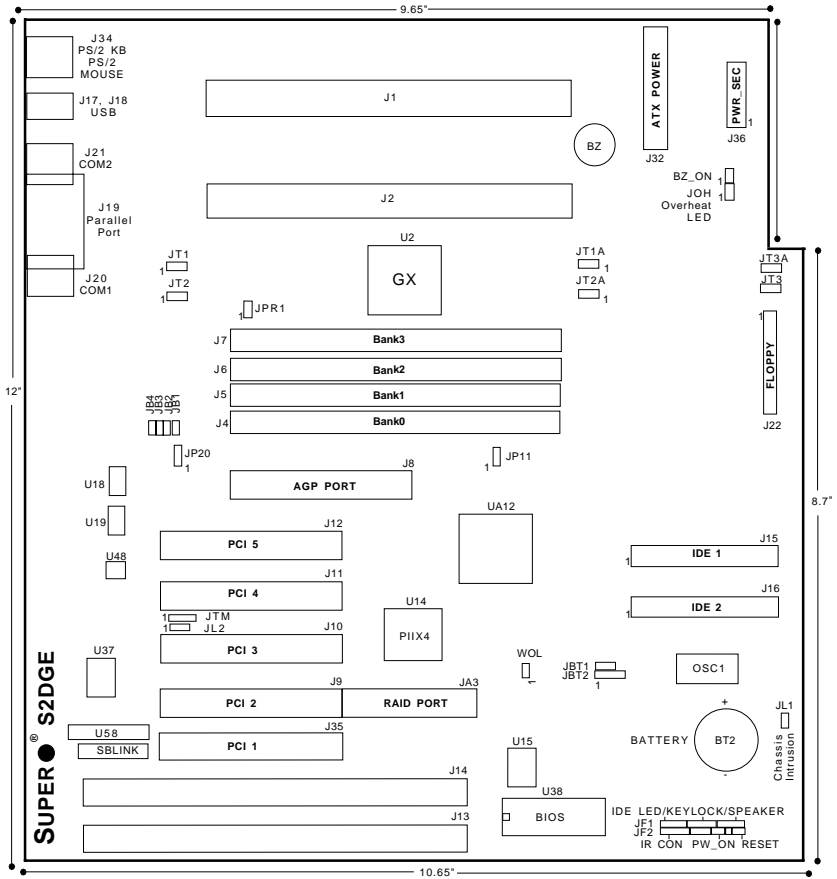

| Manufacturer Settings | |
|-----------------------|--|
| JBT1: | 1-2 (default) 2-3 CMOS Clear *To clear CMOS completely, disconnect the power source. |
| JL1: | OFF (default) ON (intrusion) |
| JP11: | ON = 66 MHz OFF = 100 MHz |
| JP20: | 1-2 PII X CTL PD State 2-3 BIOS CTL PD State (default) |
| WOL: | Wake-On-LAN |

| CPU Core/Bus Ratio | | | | |
|--------------------|-----|-----|-----|-----|
| | JB1 | JB2 | JB3 | JB4 |
| x8 | ON | OFF | ON | ON |
| x3.5 | OFF | OFF | ON | ON |
| x4 | ON | ON | OFF | ON |
| x4.5 | OFF | ON | OFF | ON |
| x5 | ON | OFF | OFF | ON |
| x5.5 | OFF | OFF | OFF | ON |
| x6 | ON | ON | ON | OFF |
| x6.5 | OFF | ON | ON | OFF |
| x7 | ON | OFF | ON | OFF |
| x7.5 | OFF | OFF | ON | OFF |

Note: To enable the overhear buzzer, place a jumper on BZ_ON.

Note: Some CPU Core/Bus ratios cannot be selected with jumpers for processors that have fixed ratios.

Figure 1-6. SUPER S2DGE Motherboard Layout

SUPER S2DGR

Figure 1-7. SUPER S2DGR Motherboard Image



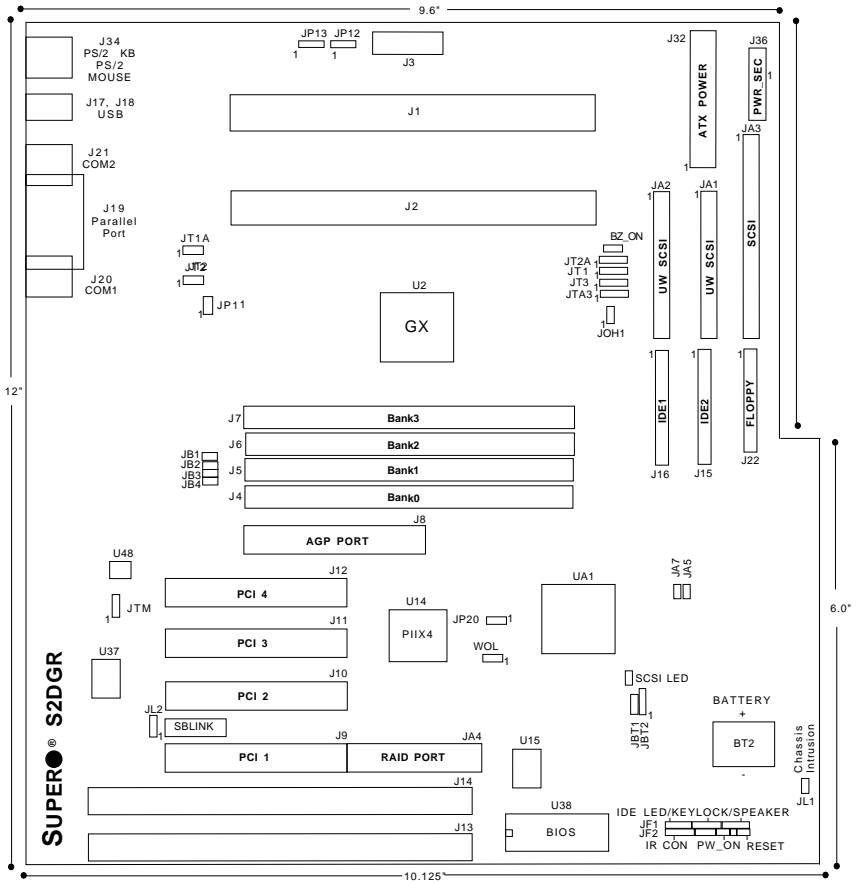

SUPER S2DGR

Manufacturer Settings

| | |
|-------|---|
| JBT1: | 1-2 (default) 2-3 CMOS Clear *To clear CMOS completely, disconnect the power source. |
| JL1: | OFF (default) ON (intrusion) |
| JP11: | ON = 66 MHz OFF = 100 MHz |
| JP20: | 1-2 PIIIX CTL PD State 2-3 BIOS CTL PD State (default) |
| WOL: | Wake-On-LAN |
| JA5: | SCSI Termination for JA1 and JA3 |
| JA6: | SCSI Termination for JA2 |

Note: To enable the overheat buzzer, place a jumper on BZ_ON.

CPU Core/Bus Ratio

| | JB1 | JB2 | JB3 | JB4 |
|------|-----|-----|-----|-----|
| x8 | ON | OFF | ON | ON |
| x3.5 | OFF | OFF | ON | ON |
| x4 | ON | ON | OFF | ON |
| x4.5 | OFF | ON | OFF | ON |
| x5 | ON | OFF | OFF | ON |
| x5.5 | OFF | OFF | OFF | ON |
| x6 | ON | ON | ON | OFF |
| x6.5 | OFF | ON | ON | OFF |
| x7 | ON | OFF | ON | OFF |
| x7.5 | OFF | OFF | ON | OFF |

Note: Some CPU Core/Bus ratios cannot be selected with jumpers for processors that have fixed ratios.

Figure 1-8. SUPER S2DGR Motherboard Layout

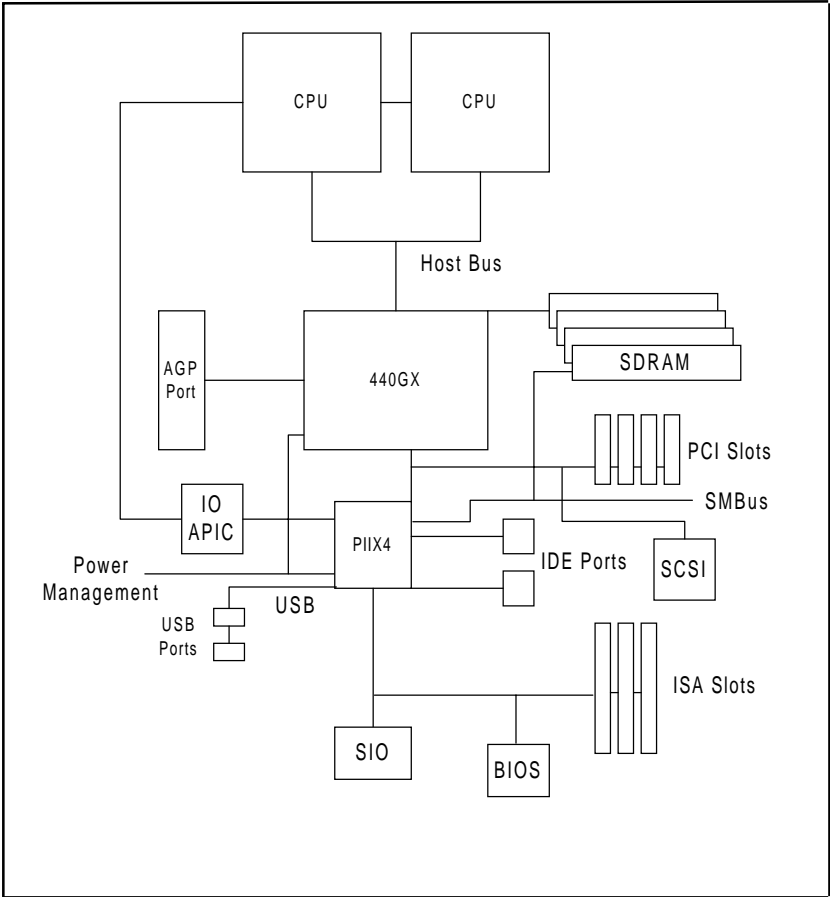

**Figure 1-9. 440GX AGP Chipset:
System Block Diagram (Dual Processors)**

NOTE: This is a general block diagram and may not represent the number of slots/CPU's on your motherboard. See the following page for the actual specifications of each motherboard.

Features of the S2DG2, S2DGU, S2DGE and S2DGR Motherboards

The following list covers the general features of the S2DG2, S2DGU, S2DGE and S2DGR motherboards.

CPU (Note: These boards may run with a single CPU in either slot.)

- Dual Pentium II Xeon and dual Pentium III Xeon processors at 100 MHz bus speed

Memory

- 2 GB unbuffered 3.3V SDRAM or 2 GB registered SDRAM
(Note: The SDRAM must be PC-100 compliant DIMMs.)
(Note: The maximum cacheable memory size depends on processor capability.)
- Error Checking and Correction and Error Checking support

Chipset

- Intel 440GX

Expansion Slots

| S2DGR | S2DG2, S2DGU, S2DGE |
|--|--|
| <ul style="list-style-type: none"> • 4 PCI slots • 2 ISA slots [one PCI/ISA shared slot] • 1 AGP slot | <ul style="list-style-type: none"> • 5 PCI slots • 2 ISA slots [one PCI/ISA shared slot] • 1 AGP slot |

BIOS

- 2 Mb AMI® Flash BIOS
- APM 1.2, DMI 2.1, Plug and Play (PnP)
- Adaptec 7890 SCSI BIOS (s2DGU)
- Adaptec 7895 SCSI BIOS (s2DGR)
- Adaptec 7896 SCSI BIOS (s2DG2)

PC Health Monitoring

- Seven onboard voltage monitors for CPU core(s), CPU I/O, +3.3V, ±5V, and ±12V
- Three-fan status monitor with firmware/software on/off control
- Environmental temperature monitor and control
- CPU fan auto-off in sleep mode
- Chassis overheat alarm, LED and control
- Chassis intrusion detection
- System resource alert
- Hardware BIOS virus protection
- Auto-switching voltage regulator for the CPU core

- SUPERMICRO SUPER Doctor and Intel® LANDesk® Client Manager (LDCM) support

ACPI/PC 98 Features

- Microsoft OnNow
- Slow blinking LED for suspend state indicator
- BIOS support for USB keyboard
- Real-time clock wake-up alarm
- Main switch override mechanism
- External modem ring-on

Onboard I/O

- Two 68-pin 16-bit Ultra2 LVD/SE SCSI connectors and one 50-pin 8-bit SCSI connector (**s2DG2**)
- One 68-pin 16-bit Ultra LVD/SE SCSI connector, one 68-pin 16-bit Ultra Wide SCSI connector and one 50-pin 8-bit SCSI connector (**s2DGU**)
- Two 68-pin 16-bit Ultra Wide SCSI connectors and one 50-pin 8-bit SCSI connector (**s2DGR**)
- RAID port for Adaptec ARO-1130CA/SA RAIDport II card (**s2DGR**)
- RAID port for Adaptec ARO-1130C RAIDport III card (**s2DG2**, **s2DGU**)
- 2 EIDE Bus Master interfaces support Ultra DMA/33 and Mode 4
- 1 floppy port interface
- 2 Fast UART 16550 serial ports
- 1 parallel port that supports EPP (Enhanced Parallel Port) and ECP (Extended Capabilities Port)
- PS/2 mouse and PS/2 keyboard
- Infrared port
- 2 USB (Universal Serial Bus) ports

CD Utilities

- Intel LANDesk Client Manager for Windows NT® and Windows® 95 (optional)
- PIIX4 Upgrade Utility for Windows 95
- BIOS Flash Upgrade Utility
- SUPER Doctor Utility
- SCSI Utility, manual and driver

Dimensions

- SUPER S2DG2 - ATX (12" x 10.65") *See board diagram for full measurements.
- SUPER S2DGU - ATX (12" x 9.65") *See board diagram for full measurements.
- SUPER S2DGE - ATX (12" x 9.65") *See board diagram for full measurements.
- SUPER S2DGR - ATX (12" x 9.6") *See board diagram for full measurements.

1-2 Chipset Overview

The 440GX chipset, developed by Intel, is the ultimate processor platform targeted for 3D graphics and multimedia applications. Along with a System-to-PCI bridge integrated with an optimized DRAM controller and data path, this chipset supports the Accelerated Graphics Port (AGP) interface. AGP is a high performance, component level interconnect targeted at 3D applications and based on a set of performance enhancements to PCI. The I/O subsystem portion of the 440GX platform is based on the PIIX4, a highly integrated version of Intel's PCI-to-ISA bridge family.

The PCI/AGP and system bus interface controller (82443GX) supports up to two Pentium II/III processors. It provides an optimized 72-bit DRAM interface (64-bit data plus ECC). This interface supports 3.3V DRAM technologies. The controller provides the interface to a PCI bus operating at 33 MHz. This interface implementation is compliant with the PCI Rev 2.1 Specification. The AGP interface is based on AGP Specification Rev 1.0. It can support data transfer rates of up to 133 MHz (532 MB/s) .

1-3 Slot 2 Architecture

The Slot 2 architecture supports Intel Pentium II and III Xeon CPUs. This technology offers a larger L2 cache that can run at full CPU speed.

1-4 PC Health Monitoring

This section describes the PC health monitoring features of the SUPER S2DG2/S2DGU/S2DGE/S2DGR. All have an onboard System Hardware Monitor chip that supports PC health monitoring.

Seven Onboard Voltage Monitors for the CPU Core(s), CPU I/O, +3.3V, $\pm 5V$, and $\pm 12V$

The onboard voltage monitor will scan these seven monitored voltages continuously. Once a voltage becomes unstable, a warning is given or an error message is sent to the screen. Users can adjust the voltage thresholds to define the sensitivity of the voltage monitor.

Three-Fan Status Monitor with Firmware/Software On/Off Control

The PC health monitor can check the RPM status of the cooling fans. The thermal fans are controlled by the overheat detection logic. **Please Note: The tachometer readings are for JT1, JT2 and JT3 only.**

Environmental Temperature Control

A thermal control sensor monitors the CPU temperature in real-time and will turn on a back-up fan whenever the CPU temperature exceeds a user-defined threshold. The overheat circuitry runs independently from the CPU. It can continue to monitor for overheat conditions even when the CPU is in sleep mode. Once it detects that the CPU temperature is too high, it will automatically turn on the back-up fan to prevent any overheat damage to the CPU. The onboard chassis thermal circuitry can monitor the overall system temperature and alert users when the chassis temperature is too high.

CPU Fan Auto-Off in Sleep Mode

The CPU fan is activated when the power is turned on. It can be turned off when the CPU is in sleep mode. When in sleep mode, the CPU will not run at full power, thereby generating less heat. For power saving purposes, the user has the option to shut down the CPU fan.

System Overheat Alarm, LED and Control

This feature is available when the user enables the system overheat warning function in BIOS (see page 5-18). The overheat alarm will activate when the system temperature exceeds the temperature threshold configured by the user. When the overheat alarm is activated, both the overheat fan and the warning LED are triggered. **Note: The alarm, fan and LED will remain on until the computer is restarted.**

Chassis Intrusion Detection

The chassis intrusion circuitry can detect unauthorized intrusion to the system. The chassis intrusion connector is located on JL1. Attach a microswitch to JL1. When the microswitch is closed, it means that the chassis has been opened. The circuitry will then alert the user with a warning message when the system is turned on. This feature is available when the user is running Intel's LANDesk Client Manager and SUPERMICRO's Super Doctor.

System Resource Alert

This feature is available when used with Intel's LANDesk Client Manager. It is used to notify the user of certain system events. For example, if the system is running low on virtual memory and there is insufficient hard drive space for saving the data, you can be alerted of the potential problem.

Hardware BIOS Virus Protection

The system BIOS is protected by hardware so that no virus can infect the BIOS area. The user can only change the BIOS contents through the flash utility provided by SUPERMICRO. This feature can prevent viruses from infecting the BIOS area and destroying valuable data.

Auto-Switching Voltage Regulator for the CPU Core

The auto-switching voltage regulator for the CPU core can support up to 20A current, with the auto-sensing voltage ID ranging from 1.3 to 3.5 volts. This will allow the regulator to run cooler and thus make the system more stable.

Intel LANDesk® Client Manager (LDCM) Support

As the computer industry grows, PC systems have become more complex and harder to manage. Historically, only experts have been able to fully understand and control these complex systems. Today's users want manageable systems that they can interact with automatically. Client Manager enables both administrators and clients to:

- Review system inventory
- View DMI-compliant component information
- Back-up and restore system configuration files
- Troubleshoot
- Receive notifications for system events
- Transfer files to and from client workstations
- Remotely boot up client workstations

1-5 ACPI/PC 98 Features

ACPI stands for Advanced Configuration and Power Interface. The ACPI specification defines a flexible and abstract hardware interface that provides a standard way to integrate power management features throughout a PC system, including hardware, the operating system and application software. This enables the system to automatically turn on and off peripherals such as CD-ROMs, network cards, hard disk drives and printers. This also includes consumer devices connected to the PC such as VCRs, TVs, telephones and stereos.

In addition to enabling operating system-directed power management, ACPI provides a generic system event mechanism for Plug and Play and an operating system-independent interface for configuration control. ACPI leverages the Plug and Play BIOS data structures while providing a processor architecture-independent implementation that is compatible with both Windows 98 and Windows NT 5.0.

Microsoft OnNow

The OnNow design initiative is a comprehensive, system-wide approach to system and device power control. OnNow is a term for a PC that is always on but appears to be off and responds immediately to user or other requests.

Slow Blinking LED for Suspend-State Indicator

When the CPU goes into a suspend state, the power LED will start blinking to indicate that the CPU is in suspend mode. When the user presses any key, the CPU will wake-up and the LED will automatically stop blinking and remain on.

BIOS Support for USB Keyboard

If the USB keyboard is the only keyboard in the system, it will work like a normal keyboard during system boot-up.

Real-Time Clock Wake-up Alarm

The PC may be perceived to be off when not in use, but is still capable of responding to preset wake-up events. In the BIOS, the user can set a timer to wake-up the system at a predetermined time (see page 5-14).

Main Switch Override Mechanism

When an ATX power supply is used, the power button can function as a system suspend button. When the user depresses the power button, the system will enter a SoftOff state. The monitor will be suspended and the hard drive will spin down. Depressing the power button again will cause the whole system to wake-up. During the SoftOff state, the ATX power supply provides power to keep the required circuitry on the system alive. In case the system malfunctions and you want to turn off the power, just depress and hold the power button for 4 seconds. The power will turn off and no power will be provided to the motherboard.

External Modem Ring-On

Wake-up events can be triggered by a device such as the external modem ringing when the system is in SoftOff state. Note that the external modem ring-on can only be used with an ATX 2.01 (or above) compliant power supply.

Wake-On-LAN (WOL)

Wake-On-LAN is defined as the ability of a management application to remotely power up a computer that is powered off. Remote PC setup, updates and asset tracking can occur after hours and on weekends so that daily LAN traffic is kept to a minimum and users are not interrupted.

The motherboards have a 3-pin header (WOL) to connect to the 3-pin header on a Network Interface Card (NIC) that has WOL capability. Note that Wake-On-LAN can only be used with an ATX 2.01 (or above) compliant power supply.

1-6 Power Supply Requirements

As with all computer products, a stable power source is necessary for proper and reliable operation. This is even more important for the 400 MHz and higher clock rates of Xeon processors.

The SUPER S2DG2/S2DGU/S2DGE/S2DGR accommodates ATX power supplies. Although most power supplies generally meet the specifications required by the CPU, some are inadequate.

It is highly recommended that you use a high quality power supply that meets ATX power supply Specification 2.01. Additionally, in areas where noisy power transmission is present, you may choose to install a line filter to shield the

computer from noise. It is recommended that you also install a power surge protector to help avoid problems caused by power surges.

1-7 Super I/O

The disk drive adapter functions of the Super I/O chip include a floppy disk drive controller compatible with industry standard 82077/765, a data separator, write pre-compensation circuitry, decode logic, data rate selection, a clock generator, drive interface control logic and interrupt and DMA logic. The wide range of functions integrated into the Super I/O greatly reduces the number of components required for interfacing with floppy disk drives. The Super I/O supports four 360 K, 720 K, 1.2 M, 1.44 M or 2.88 M disk drives and data transfer rates of 250 Kb/s, 500 Kb/s or 1 Mb/s.

It also provides two high speed serial communication ports (UARTs), one of which supports serial infrared communication. Each UART includes a 16-byte send/receive FIFO, a programmable baud rate generator, complete modem control capability and a processor interrupt system. Both UARTs provide legacy speed with baud rates of up to 115.2 Kbps as well as an advanced speed with baud rates of 230 K, 500 K or 1 Mb/s, which support higher speed modems.

The Super I/O supports one PC-compatible printer port (SPP), Bi-directional Printer Port (BPP), Enhanced Parallel Port (EPP) or Extended Capabilities Port (ECP). Extension FDD and Extension 2FDD Modes are also available through the printer port interface pins to allow one or two external floppy disk drives to be connected.

The Super I/O provides functions that comply with ACPI (Advanced Configuration and Power Interface), which includes support of legacy and ACPI power management through SMI or SCI function pins. It also features auto power management to reduce power consumption.

The Super I/O complies with the **Microsoft PC98 Hardware Design Guide**. IRQs, DMAs and I/O space resources can flexibly adjust to meet ISA PnP requirements. Moreover, it meets the specification of PC98's power management requirement: ACPI and APM (Advanced Power Management).

1-8 AIC-7890 Ultra2 SCSI Controller (S2DGU)

Note: If you are using a low voltage differential hard drive, it is recommended that you use an LVD/SE Ultra2 SCSI cable. LVD/SE cables offer increased length and can accommodate up to 15 devices.

The SUPER S2DGU has an onboard Adaptec SCSI controller that is 100% compatible with all major operating and hardware platforms. The Adaptec AIC-7890 controller provides advanced PCI-to-SCSI Ultra2 SCSI host adapter features in a 272-pin Ball Grid Array (BGA) package, as well as containing an integrated dual mode (LVD/SE) transceiver. The AIC-7890 Ultra2 SCSI chip connects to a 32-bit PCI bus. It is PCI 2.1 compliant and fully supports the power management requirements specified in the Microsoft PC98 guidelines. The AIC-7890 functions with Adaptec RAIDport III (ARO-1130C) to deliver RAID functionality.

The AIC-7890 Ultra2 SCSI controller, used together with the AIC-3860 transceiver, allows Ultra2 and single-ended devices to operate together on the same SCSI bus without impacting Ultra2 performance and cable lengths. Connectors on the S2DGU include one 68-pin 16-bit Ultra2 SCSI connector (JA1), one 68-pin 16-bit Ultra Wide SCSI connector (JA2) and one 50-pin 8-bit SCSI connector (JA4). The controller allows you to connect a total of 15 SCSI devices, with a maximum of 7 devices on the 50-pin SCSI connector.

1-9 AIC-7895 Dual Channel Ultra Wide SCSI Controller (S2DGR)

The SUPER S2DGR has an onboard Adaptec SCSI controller that is 100% compatible with all major operating and hardware platforms. PCI 2.1 compliance is assured. Two independent Ultra Wide SCSI channels provide a data transfer rate of 40 Mbytes/sec per channel. Connectors on the S2DGR include two 68-pin 16-bit Ultra Wide SCSI connectors (JA1/JA2) and one 50-pin 8-bit SCSI connector (JA3). The controller allows you to connect a total of 30 SCSI devices (15 for each channel), with a maximum of 7 devices on the 50-pin SCSI connector.

The AIC-7895 consolidates the functions of two SCSI chips, eliminating the need of a PCI bridge. Reducing PCI bus loading allows you to expand your system capabilities with additional PCI devices.

The AIC-7895 functions with Adaptec RAIDport II (ARO-1130SA/1130CA) to deliver RAID functionality. For information on installing onboard SCSI under Windows NT, refer to page 3-6 in the FAQ section of this manual.

1-10 AIC-7896 Ultra2 Dual Channel SCSI Controller (S2DG2)

The SUPER S2DG2 has an onboard Adaptec SCSI controller that is 100% compatible with all major operating and hardware platforms. PCI 2.1 compliance is assured.

The AIC-7896 Ultra2 SCSI chip connects to a 32-bit PCI bus. Two independent Ultra2 LVD SCSI channels provide a per channel data transfer rate of 80 MB/s. Connectors on the S2DG2 include two 68-pin 16-bit Ultra2 SCSI connectors (JA1 and JA2) and one 50-pin 8-bit SCSI connector (JA3). The controller allows you to connect a total of 30 SCSI devices (15 for each channel), with a maximum of 7 devices on the 50-pin SCSI connector.

The AIC-7896 consolidates the functions of two SCSI chips to eliminate the need of a PCI bridge. Reducing PCI bus loading enables system capabilities to be expanded with additional PCI devices. The AIC-7896 functions with Adaptec RAIDport III (ARO-1130C) to deliver dual channel RAID functionality.

The AIC-7896 SCSI host adapter meets the highest performance requirements of today. It can deliver Ultra2 SCSI data transfer rates of up to 80 Mbytes/sec per channel, for a total throughput of 160 Mbytes/sec. It was designed to meet the needs of bandwidth-hungry applications, such as high-level simulations, real-time video and data mining.

Chapter 2

Installation

2-1 Static-Sensitive Devices

Static-sensitive electrical discharge can damage electronic components. To prevent damage to your system board, it is important to handle it very carefully. The following measures are generally sufficient to protect your equipment from static discharge.

Precautions

- Use a grounded wrist strap designed to prevent static discharge.
- Touch a grounded metal object before you remove the board from the antistatic bag.
- Handle the board by its edges only; do not touch its components, peripheral chips, memory modules or gold contacts.
- When handling chips or modules, avoid touching their pins.
- Put the system board and peripherals back into their antistatic bags when not in use.
- For grounding purposes, make sure your computer system's chassis provides excellent conductivity between the power supply, the case, the mounting fasteners and the system board.

Unpacking

The system board is shipped in antistatic packaging to avoid static damage. When unpacking the board, be sure the person handling the board is static-protected.

2-2 Pentium II and III Xeon Processor Installation

Note: These instructions are for the retail pack with a passive heatsink. OEM Pentium II/III Xeon processors also require a heat sink (not included).



When installing the Pentium II/III Xeon processor, the DRM (Dual Retention Module) must be bolted to the chassis. This provides the processor with support against shock and vibration.



When handling the Pentium II/III Xeon processor, avoid placing direct pressure to the label area of the fan.

1. Installing the metal standoffs:

Attach the metal standoffs to the back of the motherboard tray. Be sure the location of all the mounting holes for both the motherboard and the chassis match. Make sure the metal standoffs click in or are screwed in tightly. There are three additional metal standoffs, specifically for the Slot 2 motherboard, that are required for mounting the DRM (Dual Retention Module). See Figure 2-1 for mounting hole locations.

2. Mounting the motherboard onto the motherboard tray:

Except for the four Slot 2 mounting holes, use a Philips screwdriver to first secure the motherboard onto the motherboard tray.

3. Mounting the fans and the Dual Retention Module (See Figure 2-2):

Before mounting the retention base, you first need to mount the fans in their proper locations. Screw the base retention parts into the four Slot 2 mounting holes. **Note: The DRM needs to be bolted through the motherboard to the chassis.**

4. Placing the fasteners:

Place a fastener on top of each side of the base, with the arm on top and the screw holes underneath.

5. Installing caps on the Xeon processor as a handlebar:

When attaching the caps for each Xeon processor, make sure the directions of the mounting screw holes on each cap face the inside so that the CPU unit can easily slide in. Please test the configuration of the units before mounting the caps.

6. Securing the processor:

Slide in the single/dual processor(s) making sure it sits on the Slot 2 socket. Then, insert four of the screws included in the DRM kit and secure the fastener down tightly.

Removing the Pentium II/III Xeon Processor

To remove the Pentium II/III processor from the motherboard, follow the reverse of the installation process.



When removing the Pentium II/III processor, avoid pressing down on the motherboard or components.

Figure 2-1. Dual Retention Module Mounting Holes

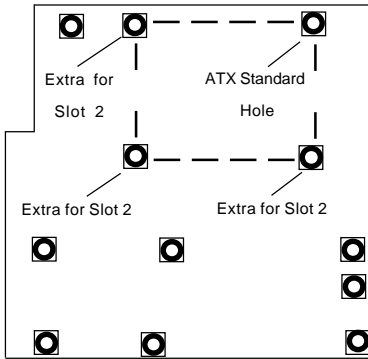

*Back view of motherboard

When mounting the motherboard to the chassis, note that you will use three holes specifically for mounting the Slot 2 DRM as well as one ATX Standard hole to secure the Slot 2 DRM.

Figure 2-2. Installing the Processor

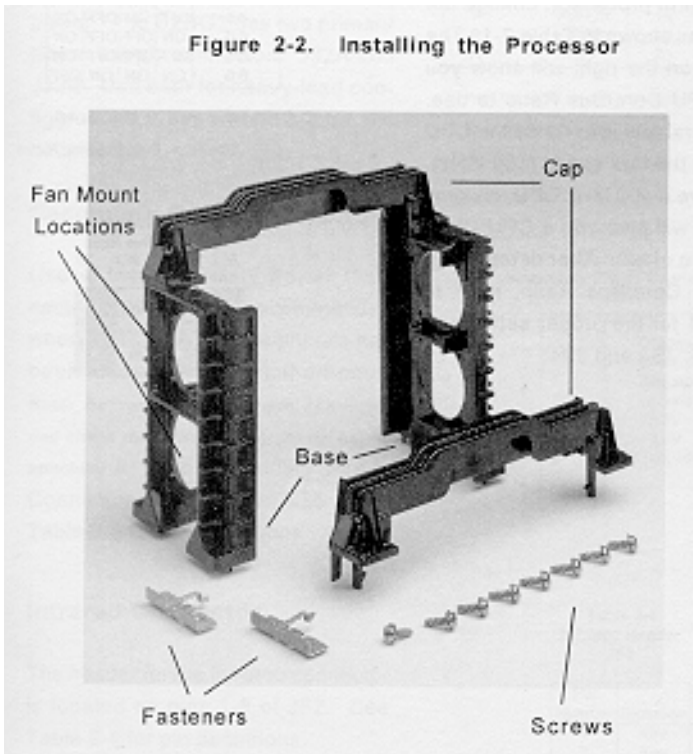

2-3 Explanation and Diagram of Jumper/Connector

To modify the operation of the motherboard, jumpers can be used to choose between optional settings. Jumpers create shorts between two pins to change the function of the connector. Pin 1 is identified with a square.

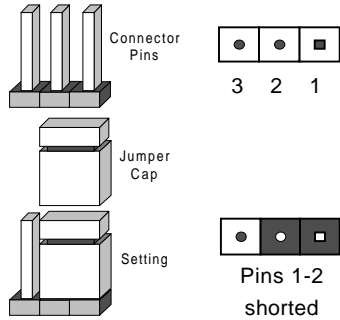

2-4 Changing the CPU Speed

To change the CPU speed for a Pentium II/III processor, change the jumpers as shown in Table 2-1. The example on the right will show you which CPU Core/Bus Ratio to use. The general rule is to divide the CPU speed by the bus speed (100 MHz). If you have a 400 MHz CPU, dividing it by 100 will give you a CPU Core/BUS Ratio of 4.0. After determining the CPU Core/Bus Ratio, refer to Table 2-1 for the proper settings of JB1, JB2, JB3 and JB4.

Table 2-1
Pentium II/III Speed Selection

| CPU Core/Bus Ratio | JB1 | JB2 | JB3 | JB4 |
|--------------------|-----|-----|-----|-----|
| 3.0 | ON | OFF | ON | ON |
| 3.5 | OFF | OFF | ON | ON |
| 4.0 | ON | ON | OFF | ON |
| 4.5 | OFF | ON | OFF | ON |
| 5.0 | ON | OFF | OFF | ON |
| 5.5 | OFF | OFF | OFF | ON |
| 6.0 | ON | ON | ON | OFF |
| 6.5 | OFF | ON | ON | OFF |
| 7.0 | ON | OFF | ON | OFF |
| 7.5 | OFF | OFF | ON | OFF |

400 MHz = 100 MHz x 4.0

CPU Speed = Bus Freq. x Ratio

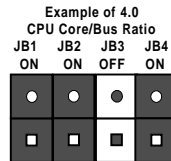

2-5 Mounting the Motherboard in the Chassis

All the motherboards have standard mounting holes to fit different types of chassis. Chassis may come with a variety of mounting fasteners made of metal or plastic. Although a chassis may have both metal and plastic fasteners, metal fasteners are the most highly recommended because they ground the system board to the chassis. Therefore, use as many metal fasteners as possible for better grounding.

2-6 Connecting Cables

Power Supply Connector

After you have securely mounted the motherboard to the chassis, you are ready to connect the cables. Attach a power supply cable to J32 for ATX power. The S2DG2 has two primary power supply connectors: J32A and J32B. You should use both primaries *and* the secondary connector if included with your power supply. See Table 2-2 for pin definitions.

Table 2-2
ATX Power Supply Connector
J32

| Pin Number | Definition | Pin Number | Definition |
|------------|------------|------------|------------|
| 1 | 3.3V | 11 | 3.3V |
| 2 | 3.3V3 | 12 | -12V |
| 3 | Ground | 13 | Ground |
| 4 | 5V | 14 | PS-ON |
| 5 | Ground | 15 | Ground |
| 6 | 5V | 16 | Ground |
| 7 | Ground | 17 | Ground |
| 8 | PW-OK | 18 | -5V |
| 9 | 5VSB | 19 | 5V |
| 10 | 12V | 20 | 5V |

Note: The S2DG2 has two primary power supply connectors located at J32A and J32B.

Secondary Power Connector

Use of the Secondary Power Connector (PWR_SEC) is recommended when a heavy load of peripherals has been added to the motherboard.

Note: *Be sure to use a 6-pin connector and check the power supply layout before attaching it.* The Secondary Power Connector is located on J36. See Table 2-3 for pin definitions.

Table 2-3
Secondary Power Connector
J36

| Pin Number | Definition |
|------------|-------------|
| 1 | Ground |
| 2 | Ground |
| 3 | Ground |
| 4 | +3.3V |
| 5 | +3.3V |
| 6 | +5V (keyed) |

Infrared Connector

The header for the infrared connector is located on pins 1-5 of JF2. See Table 2-4 for pin definitions.

Table 2-4
Infrared Header
JF2

| Pin Number | Definition |
|------------|------------|
| 1 | +5V |
| 2 | Key |
| 3 | IRRX |
| 4 | Ground |
| 5 | IRTX |

PW_ON Connector

The header for the PW_ON connector is located on pins 9 and 10 of JF2. Momentarily contacting both pins will power on/off the system. The user can also configure this button to function as a suspend button. (See BIOS setup information on page 5-12). To turn off the power when set to suspend mode, hold down the power button for at least 4 seconds. See Table 2-5 for pin definitions.

Table 2-5
PW_ON Header
JF2

| Pin Number | Definition |
|------------|------------|
| 9 | PW_ON |
| 10 | Ground |

Reset Connector

The header for the reset connector is located on pins 12 and 13 of JF2. This is used for the hardware reset switch on the computer case. See Table 2-6 for pin definitions.

Table 2-6
Reset Header
JF2

| Pin Number | Definition |
|------------|------------|
| 12 | Ground |
| 13 | Reset |

Hard Drive LED

The header for the hard drive LED is located on pins 1 to 4 of JF1. Attach the hard drive LED cable to pins 1 and 2. See Table 2-7 for pin definitions.

Table 2-7
Hard Drive LED Header
JF1

| Pin Number | Definition |
|------------|------------|
| 1 | +5V |
| 2 | HD Active |
| 3 | HD Active |
| 4 | +5V |

Keylock/Power LED Connector

The header for the keylock/power LED connector is located on pins 5 to 9 of JF1. Pins 5 through 7 are for the power LED and pins 8 and 9 are for the keylock. See Table 2-8 for pin definitions.

Table 2-8
Keylock/Power LED Header
JF1

| Pin Number | Function | Definition |
|------------|----------|---------------------|
| 5 | VCC +5V | Red wire, LED power |
| 6 | VCC +5V | Red wire, LED power |
| 7 | Ground | LED control |
| 8 | Ground | Keyboard inhibit |
| 9 | Ground | Black wire |

Speaker Connector

The header for the speaker connector is located on pins 10 to 13 of JF1. See Table 2-9 for pin definitions.

Table 2-9
Speaker Header
JF1

| Pin Number | Function | Definition |
|------------|----------|------------------------|
| 10 | + | Red wire, Speaker data |
| 11 | Key | No connection |
| 12 | | Key |
| 13 | | Speaker data |

Power Save State Select

Refer to Table 2-10 to set JP20. The Power Save State is used when you want the system to remain in the power-off state when you first apply power to the system or when the system recovers from an AC power failure. In this state, the power will not come on unless you hit the power switch on the motherboard. PIIX4 control is used if you want the system to be in the power-on state the first time you apply power to the system or when the system recovers from an AC power failure.

Table 2-10
Power Save State Select
JP20

| Jumper Position | Definition |
|-----------------|---------------|
| 1-2 | PIIX4 Ctrl |
| 2-3 | Save PD State |

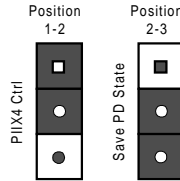

ATX PS/2 Keyboard and Mouse Ports

The ATX PS/2 keyboard and the PS/2 mouse ports are located on J34. See Table 2-11 for pin definitions.

Table 2-11
ATX PS/2
Keyboard
and Mouse Ports
J34

| Pin Number | Definition |
|------------|------------|
| 1 | Data |
| 2 | NC |
| 3 | Ground |
| 4 | VCC |
| 5 | Clock |
| 6 | NC |

Universal Serial Bus

The two Universal Serial Bus connectors are located on J17 and J18. See Table 2-12 for pin definitions.

Table 2-12
Universal Serial Bus

J17

J18

| Pin Number | Definition | Pin Number | Definition |
|------------|------------|------------|------------|
| 1 | +5V | 1 | +5V |
| 2 | P0- | 2 | P0- |
| 3 | P0+ | 3 | P0+ |
| 4 | Ground | 4 | Ground |
| 5 | N/A | 5 | Key |

ATX Serial Ports

ATX serial port COM1 is located on J20 and serial port COM2 is located on J21. See Table 2-13 for pin definitions.

Table 2-13
ATX Serial Ports

| J20 | | J21 | |
|------------|------------|------------|------------|
| Pin Number | Definition | Pin Number | Definition |
| 1 | DCD | 6 | CTS |
| 2 | DSR | 7 | DTR |
| 3 | Serial In | 8 | RI |
| 4 | RTS | 9 | Ground |
| 5 | Serial Out | 10 | NC |

CMOS Clear

Refer to Table 2-14 for instructions on how to clear CMOS. **For an ATX power supply, you need to completely shut down the system, and then use JBT1 to clear CMOS. Do not use the PW_ON connector to clear CMOS.** A second way of resetting the CMOS contents is by pressing the <Ins> key and then turning on the system power. Release the key when the power comes on.

Table 2-14
CMOS Clear
JBT1

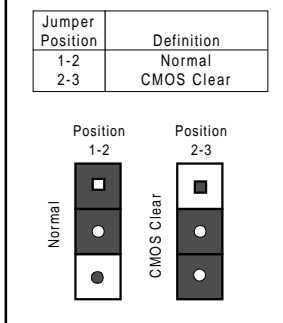

External Battery

Connect an external battery to JBT2. Refer to Table 2-15 for pin definitions.

Table 2-15
External Battery
JBT2

| Pin Number | Definition |
|------------|------------|
| 1 | +3V |
| 2 | NC |
| 3 | NC |
| 4 | Ground |

Wake-On-LAN

The Wake-On-LAN connector is located on WOL. Refer to Table 2-16 for pin definitions.

Table 2-16
Wake-On-LAN
WOL

| Pin Number | Definition |
|------------|-------------|
| 1 | +5V Standby |
| 2 | Ground |
| 3 | Wake up |

Fan Connectors*

The thermal/overheat fans are located on JT3 and JT3A. The CPU fans are located on JT1, JT1A, JT2 and JT2A. **Note: JT1A, JT2A and JT3A do not have tachometers.** Refer to Table 2-17 for pin definitions.

Table 2-17
Fan Connectors
JT1, JT1A, JT2, JT2A,
JT3 and JT3A

| Pin Number | Definition |
|------------|----------------|
| 1 | Ground (black) |
| 2 | +12V (red) |
| 3 | Tachometer |

* Caution: These fan connectors are DC direct.

Note: JT1A, JT2A and JT3A do not have tachometers.

Chassis Intrusion

The Chassis Intrusion Detector is located on JL1. See the board layouts in Chapter 1 and the PC Health Monitor information on page 1-14 for more information. See Table 2-18 for pin definitions.

Table 2-18
Chassis Intrusion
JL1

| Pin Number | Definition |
|------------|-----------------|
| 1 | Intrusion Input |
| 2 | Ground |

Open = Default Closed = Intrusion

SLED (SCSI LED) Indicator

The SLED connector is used to provide an LED indication of SCSI activity. Refer to Table 2-19 for connecting the SCSI LED.

Table 2-19
SLED Pin Definitions

| Pin Number | Definition |
|------------|------------|
| 1 | Positive |
| 2 | Negative |
| 3 | Negative |
| 4 | Positive |

2-7 Installing DIMMs

CAUTION

Exercise extreme care when installing or removing DIMMs to prevent any possible damage.

DIMM Installation

1. Insert DIMM modules in Bank 0 through Bank 3 as required for the desired system memory.
2. Insert each DIMM module vertically into its socket. Pay attention to the notches along the bottom of the module to prevent inserting the DIMM incorrectly.
3. Gently press down on the DIMM module until it snaps upright and into place in the socket.
4. For best results, install DIMMs starting from Bank 0.

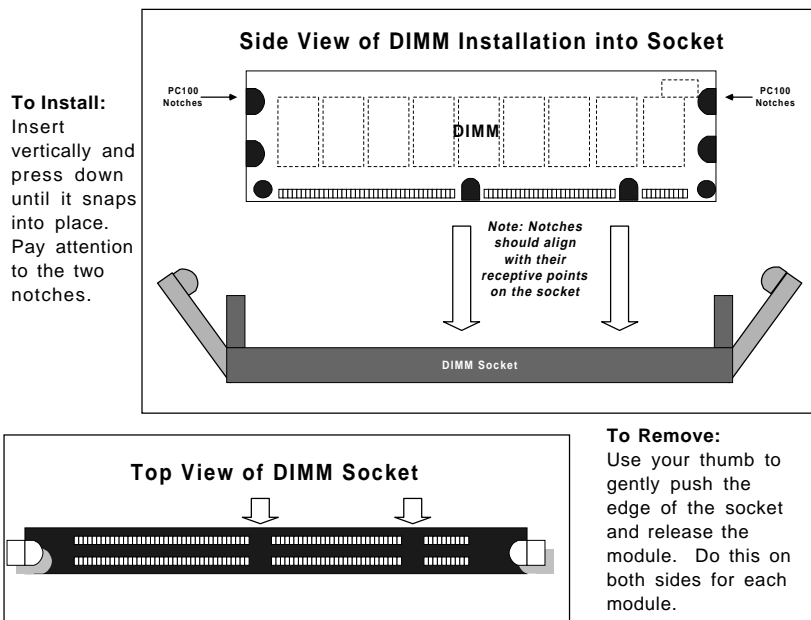

Figure 2-3. DIMM Installation

2-8 Connecting the Parallel Port, Floppy and Hard Disk Drives

Use the following information to connect the floppy and hard disk drive cables.

- The floppy disk drive cable has seven twisted wires.
- A red mark on a wire typically designates the location of pin 1.
- A single floppy disk drive ribbon cable has 34 wires and two connectors to provide for two floppy disk drives. The connector with the twisted wires always connects to drive A, and the connector without the twisted wires always connects to drive B.
- An IDE hard disk drive requires a data ribbon cable with 40 wires, and a SCSI hard disk drive requires a SCSI ribbon cable with 50 wires. A wide SCSI hard disk drive requires a SCSI ribbon cable with 68 wires.
- A single IDE hard disk drive cable has two connectors to provide for two drives. To designate an IDE disk drive as C, you would normally set the drive select jumper on the drive to DS1 (or Master). To designate an IDE disk drive as D, you would normally set the drive select jumper on the drive to DS2 (or Slave). Consult the documentation that came with your disk drive for details on actual jumper locations and settings.
- A single SCSI ribbon cable typically has three connectors to provide for two

hard disk drives and the SCSI adapter. (Note: Most SCSI hard drives are single-ended SCSI devices.) The SCSI ID is determined either by jumpers or by a switch on the SCSI device. The last internal (and external) SCSI device cabled to the SCSI adapter must be terminated.

Table 2-19
Parallel Port Connector J19

| Pin Number | Function | Pin Number | Function |
|------------|------------|------------|------------|
| 1 | Strobe- | 2 | Auto Feed- |
| 3 | Data Bit 0 | 4 | Error- |
| 5 | Data Bit 1 | 6 | Init- |
| 7 | Data Bit 2 | 8 | SLCT IN- |
| 9 | Data Bit 3 | 10 | GND |
| 11 | Data Bit 4 | 12 | GND |
| 13 | Data Bit 5 | 14 | GND |
| 15 | Data Bit 6 | 16 | GND |
| 17 | Data Bit 7 | 18 | GND |
| 19 | ACK | 20 | GND |
| 21 | BUSY | 22 | GND |
| 23 | PE | 24 | GND |
| 25 | SLCT | 26 | NC |

Parallel Port Connector

The parallel port is located on J19.
See Table 2-19 for pin definitions.

Table 2-20
Floppy Connector J22

| Pin Number | Function | Pin Number | Function |
|------------|----------|------------|-----------------|
| 1 | GND | 2 | FDHDIN |
| 3 | GND | 4 | Reserved |
| 5 | Key | 6 | FDDEDIN |
| 7 | GND | 8 | Index- |
| 9 | GND | 10 | Motor Enable |
| 11 | GND | 12 | Drive Select B- |
| 13 | GND | 14 | Drive Select A- |
| 15 | GND | 16 | Motor Enable |
| 17 | GND | 18 | DIR- |
| 19 | GND | 20 | STEP- |
| 21 | GND | 22 | Write Data- |
| 23 | GND | 24 | Write Gate- |
| 25 | GND | 26 | Track 00- |
| 27 | GND | 28 | Write Protect- |
| 29 | GND | 30 | Read Data- |
| 31 | GND | 32 | Side 1 Select- |
| 33 | GND | 34 | Diskette |

Floppy Connector

The floppy connector is located on J22. See Table 2-20 for pin definitions.

Table 2-21
IDE Connectors J15 and J16

| Pin Number | Function | Pin Number | Function |
|------------|---------------|------------|----------------|
| 1 | Reset IDE | 2 | GND |
| 3 | Host Data 7 | 4 | Host Data 8 |
| 5 | Host Data 6 | 6 | Host Data 9 |
| 7 | Host Data 5 | 8 | Host Data 10 |
| 9 | Host Data 4 | 10 | Host Data 11 |
| 11 | Host Data 3 | 12 | Host Data 12 |
| 13 | Host Data 2 | 14 | Host Data 13 |
| 15 | Host Data 1 | 16 | Host Data 14 |
| 17 | Host Data 0 | 18 | Host Data 15 |
| 19 | GND | 20 | Key |
| 21 | DRQ3 | 22 | GND |
| 23 | I/O Write- | 24 | GND |
| 25 | I/O Read- | 26 | GND |
| 27 | IOCHRDY | 28 | BALE |
| 29 | DACK3- | 30 | GND |
| 31 | IRQ14 | 32 | IOCS16- |
| 33 | Addr 1 | 34 | GND |
| 35 | Addr 0 | 36 | Addr 2 |
| 37 | Chip Select 0 | 38 | Chip Select 1- |
| 39 | Activity | 40 | GND |

IDE Interfaces

There are no jumpers to configure the onboard IDE interfaces J15 and J16. Refer to Table 2-21 for pin definitions.

Table 2-22
Ultra Wide SCSI Connector

| Pin Number | Function | Pin Number | Function |
|------------|----------|------------|----------|
| 1 | GND | 35 | -DB (12) |
| 2 | GND | 36 | -DB (13) |
| 3 | GND | 37 | -DB (14) |
| 4 | GND | 38 | -DB (15) |
| 5 | GND | 39 | Parity H |
| 6 | GND | 40 | -DB (0) |
| 7 | GND | 41 | -DB (1) |
| 8 | GND | 42 | -DB (2) |
| 9 | GND | 43 | -DB (3) |
| 10 | GND | 44 | -DB (4) |
| 11 | GND | 45 | -DB (5) |
| 12 | GND | 46 | -DB (6) |
| 13 | GND | 47 | -DB (7) |
| 14 | GND | 48 | Parity L |
| 15 | GND | 49 | GND |
| 16 | GND | 50 | Termprwd |
| 17 | Termprwd | 51 | Termprwd |
| 18 | Termprwd | 52 | Termprwd |
| 19 | GND | 53 | NC |
| 20 | GND | 54 | GND |
| 21 | GND | 55 | -ATTN |
| 22 | GND | 56 | GND |
| 23 | GND | 57 | -BSY |
| 24 | GND | 58 | -ACK |
| 25 | GND | 59 | -RST |
| 26 | GND | 60 | -MSG |
| 27 | GND | 61 | -SEL |
| 28 | GND | 62 | -CD |
| 29 | GND | 63 | -REQ |
| 30 | GND | 64 | -IO |
| 31 | GND | 65 | -DB (8) |
| 32 | GND | 66 | -DB (9) |
| 33 | GND | 67 | -DB (10) |
| 34 | GND | 68 | -DB (11) |

SCSI Connectors

There are no jumpers to configure the onboard, single-ended SCSI interface. Refer to Table 2-22 for the Ultra Wide SCSI pin definitions. Refer to Table 2-23 for the 50-pin SCSI pin definitions.

Table 2-23
50-Pin SCSI Connector

| Pin Number | Function | Pin Number | Function |
|------------|----------|------------|----------|
| 1 | GND | 26 | -DB (0) |
| 2 | GND | 27 | -DB (1) |
| 3 | GND | 28 | -DB (2) |
| 4 | GND | 29 | -DB (3) |
| 5 | GND | 30 | -DB (4) |
| 6 | GND | 31 | -DB (5) |
| 7 | GND | 32 | -DB (6) |
| 8 | GND | 33 | -DB (7) |
| 9 | GND | 34 | -DB (P) |
| 10 | GND | 35 | GND |
| 11 | GND | 36 | GND |
| 12 | Reserved | 37 | Reserved |
| 13 | Open | 38 | Termprwr |
| 14 | Reserved | 39 | Reserved |
| 15 | GND | 40 | GND |
| 16 | GND | 41 | -ATN |
| 17 | GND | 42 | GND |
| 18 | GND | 43 | -BSY |
| 19 | GND | 44 | -ACK |
| 20 | GND | 45 | -RST |
| 21 | GND | 46 | -MSG |
| 22 | GND | 47 | -SEL |
| 23 | GND | 48 | -C/D |
| 24 | GND | 49 | -REQ |
| 25 | GND | 50 | -I/O |

Table 2-24
Ultra2 LVD/SE SCSI Connector

| Connector Contact Number | Signal Names | Connector Contact Number | Signal Names |
|--------------------------|--------------|--------------------------|--------------|
| 1 | +DB(12) | 35 | -DB(12) |
| 2 | +DB(13) | 36 | -DB(13) |
| 3 | +DB(14) | 37 | -DB(14) |
| 4 | +DB(15) | 38 | -DB(15) |
| 5 | +DB(P1) | 39 | -DB(P1) |
| 6 | +DB(0) | 40 | -DB(0) |
| 7 | +DB(1) | 41 | -DB(1) |
| 8 | +DB(2) | 42 | -DB(2) |
| 9 | +DB(3) | 43 | -DB(3) |
| 10 | +DB(4) | 44 | -DB(4) |
| 11 | +DB(5) | 45 | -DB(5) |
| 12 | +DB(6) | 46 | -DB(6) |
| 13 | +DB(7) | 47 | -DB(7) |
| 14 | +DB(P) | 48 | -DB(P) |
| 15 | GROUND | 49 | GROUND |
| 16 | DIFFSENS | 50 | GROUND |
| 17 | TERMPWR | 51 | TERMPWR |
| 18 | TERMPWR | 52 | TERMPWR |
| 19 | RESERVED | 53 | RESERVED |
| 20 | GROUND | 54 | GROUND |
| 21 | +ATN | 55 | -ATN |
| 22 | GROUND | 56 | GROUND |
| 23 | +BSY | 57 | -BSY |
| 24 | +ACK | 58 | -ACK |
| 25 | +RST | 59 | -RST |
| 26 | +MSG | 60 | -MSG |
| 27 | +SEL | 61 | -SEL |
| 28 | +C/D | 62 | -C/D |
| 29 | +REQ | 63 | -REQ |
| 30 | +I/O | 64 | -I/O |
| 31 | +DB(8) | 65 | -DB(8) |
| 32 | +DB(9) | 66 | -DB(9) |
| 33 | +DB(10) | 67 | -DB(10) |
| 34 | +DB(11) | 68 | -DB(11) |

Ultra2 LVD/SE SCSI Connector

Refer to Table 2-24 for the Ultra2 LVD/SE SCSI pin definitions.

Table 2-25
AGP Port J8

| Pin # | B | A | Pin # | B | A |
|-------|---------|-----------|-------|---------|----------|
| 1 | Spare | 12V | 34 | Vddq3.3 | Vddq3.3 |
| 2 | 5.0V | Spare | 35 | AD21 | AD22 |
| 3 | 5.0V | Reserved* | 36 | AD19 | AD20 |
| 4 | USB+ | USB- | 37 | GND | GND |
| 5 | GND | GND | 38 | AD17 | AD18 |
| 6 | INTB# | INTA# | 39 | C/BE2# | AD16 |
| 7 | CLK | RST# | 40 | Vddq3.3 | Vddq3.3 |
| 8 | REQ# | GNT# | 41 | IRDY# | Frame# |
| 9 | VCC3.3 | VCC3.3 | 42 | | |
| 10 | ST0 | ST1 | 43 | GND | GND |
| 11 | ST2 | Reserved | 44 | | |
| 12 | RBF# | PIPE# | 45 | VCC3.3 | VCC3.3 |
| 13 | GND | GND | 46 | DEVSEL# | TRDY# |
| 14 | Spare | Spare | 47 | Vddq3.3 | STOP# |
| 15 | SBA0 | SBA1 | 48 | PERR# | Spare |
| 16 | VCC3.3 | VCC3.3 | 49 | GND | GND |
| 17 | SBA2 | SBA3 | 50 | SERR# | PAR |
| 18 | SB_STB | Reserved | 51 | C/BE1# | AD15 |
| 19 | GND | GND | 52 | Vddq3.3 | Vddq3.3 |
| 20 | SBA4 | SBA5 | 53 | AD14 | AD13 |
| 21 | SBA6 | SBA7 | 54 | AD12 | AD11 |
| 22 | KEY | KEY | 55 | GND | GND |
| 23 | KEY | KEY | 56 | AD10 | AD9 |
| 24 | KEY | KEY | 57 | AD8 | C/BE0# |
| 25 | KEY | KEY | 58 | Vddq3.3 | Vddq3.3 |
| 26 | AD31 | AD30 | 59 | AD_STB0 | Reserved |
| 27 | AD29 | AD28 | 60 | AD7 | AD6 |
| 28 | VCC3.3 | VCC3.3 | 61 | GND | GND |
| 29 | AD27 | AD26 | 62 | AD5 | AD4 |
| 30 | AD25 | AD24 | 63 | AD3 | AD2 |
| 31 | GND | GND | 64 | Vddq3.3 | Vddq3.3 |
| 32 | AD_STB1 | Reserved | 65 | AD1 | AD0 |
| 33 | AD23 | C/BE3# | 66 | SMB0 | SMB1 |

AGP Port

There are no jumpers to configure AGP port J8. Refer to Table 2-25 for pin definitions.

Chapter 3 Troubleshooting

3-1 Troubleshooting Procedures

Use the following procedures and chart to troubleshoot your system. If you have followed all the procedures below and still need assistance, refer to the 'Technical Support Procedures' and/or 'Returning Merchandise for Service' section(s) in this chapter.

Before Power On

1. Make sure no short circuits exist between the motherboard and chassis.
2. Disconnect all ribbon/wire cables from the motherboard.
3. Remove all add-on cards except for the video/graphics card. (Be sure the video/graphics card is inserted properly.)
4. Install a CPU, the chassis speaker and the power LED to the motherboard. (Check all jumper settings as well.)
5. Install a memory module into one bank.
6. Check the power supply voltage monitor 115V/230V switch.

Figure 3-1. Troubleshooting Flowchart

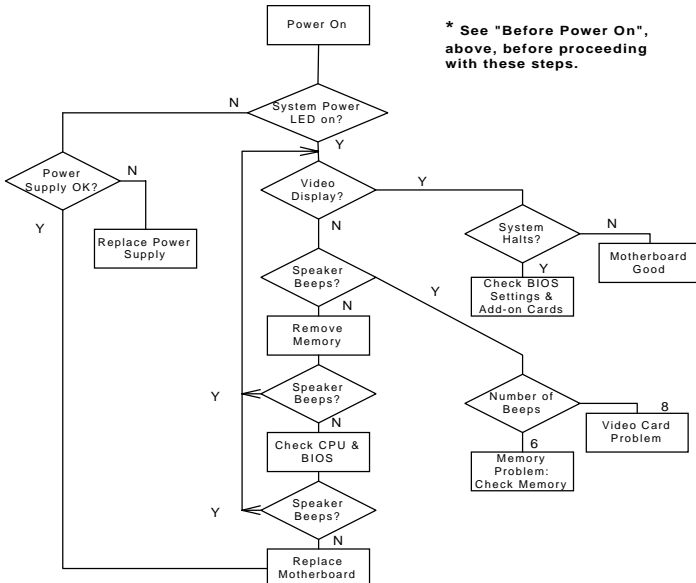

No Power

1. Make sure that the default jumper is on and the CPU is correctly set up.
2. Turn the power switch on and off to test the system.
3. If the power is still not on, turn the system power off and change the jumper setting on JP20 from 2-3 to 1-2.
4. If changing the jumper setting has not helped, clear CMOS.
5. Check the power supply voltage monitor. (Check the power supply 115V/230V switch.)

No Video

Use the following steps to troubleshoot your system configuration.

1. If the power is on but you have no video, remove all the add-on cards and cables.
2. Check for shorted connections, especially under the motherboard.
3. Check the jumpers settings, clock speed and voltage settings.
4. Use the speaker to determine if any beep codes exist. Refer to Appendix A for details on beep codes.

NOTE

If you are a system integrator, VAR or OEM, a POST diagnostics card is recommended. For port 80h codes, refer to Appendix B.

Memory Errors

If you encounter memory errors, follow the procedures below.

1. Check to determine if the DIMM modules are improperly installed.
2. Make sure that different types of DIMMs have not been installed in different banks (e.g., a mixture of 2 MB x 36 and 1 MB x 36 DIMMs in Bank 0).
3. Determine if DIMMs of different speeds have been installed and verify that the BIOS setup is configured for the fastest speed of RAM used. It is recommended to use the same RAM speed for all DIMMs in the system.
4. Check for bad DIMM modules or chips.
5. Try to install the minimum amount of memory first (a single bank).

Losing the System's Setup Configuration

1. Check the setting of jumper JBT1. Ensure that you are using a high quality power supply. A poor quality power supply may cause the system to lose the CMOS setup. Refer to Chapter 1 of this manual for details.
2. If the above step does not fix the Setup Configuration problem, contact your vendor for repairs.

3-2 Technical Support Procedures

1. Please go through the 'Troubleshooting Procedures' and 'Frequently Asked Question' (FAQ) sections in this chapter of the manual or check our web site FAQ (<http://www.supermicro.com>) before contacting Technical Support.
2. Take note that as a motherboard manufacturer Super Micro does not sell directly to end-users, so it is best to check with your distributor or reseller for troubleshooting services. They should know of any possible problem(s) with the specific system configuration that was sold to you.
3. BIOS upgrades can be downloaded from the SUPER BBS# (408) 895-2022, 24 hours a day, using 1200-28800 baud, 8 data bits, 1 stop bit and no parity. BIOS upgrades can also be downloaded from our web site at <http://www.supermicro.com>.

Note: Not all BIOS can be flashed depending on the modifications to the boot block code.

4. If you still cannot resolve the problem, include the following information when you e-mail Super Micro for technical support:
 - BIOS release date/version
 - System board serial number
 - Product model name
 - Invoice number and date
 - System configuration

Due to the volume of e-mail we receive and the time it takes to replicate problems, a response to your question may not be immediately available. Please understand that we do not have the resources to serve every end-user, however, we will try our best to help all of our customers.
5. Distributors: For immediate assistance, please have your account number ready when placing a call to our technical support department.

3-3 Frequently Asked Questions

Question: Do I need to change any settings to use a single processor on a dual processor board?

Answer: There are no jumpers or BIOS settings that need to be changed when running a single CPU on a dual processor board. Also, you can use a single processor in either slot.

Question: What are the differences between the various memories that the 440GX motherboard can support?

Answer: The 440GX integrates a main memory DRAM controller that supports 64-bit or 72-bit (64 bit memory data plus 8 ECC bits) DRAM for 8 MB to 512 MB of SDRAM and 8 MB to 2 GB of SDRAM/registered DIMMs. The DRAM types supported are either Synchronous DRAM (SDRAM) or registered DIMMs.

1. Mixing ECC and non-ECC memory will result in non-ECC operation.

EC/ECC is supported properly in the 440GX only if all memory is 72 bits wide. A system with a mixture of 64- and 72-bit wide memory will disable ECC mode.

2. Registered SDRAM and unbuffered SDRAM cannot be mixed.

3. Mixing PC/100 DIMM and PC/66 DIMM will result in an unexpected memory count or system errors.

4. User should populate memory starting with the DIMM socket located furthest from the GX chip (slot J4).

Question: How do I update my BIOS?

Answer: It is recommended that you **do not** upgrade your BIOS if you are experiencing no problems with your system. Updated BIOS files are located on our web site at <http://www.supermicro.com>. Please check our BIOS warning message and the info on how to update it. Also, check the current BIOS revision and make sure it is newer than your BIOS before downloading. Select your motherboard model and download the proper BIOS file to your computer. Unzip the BIOS update file and you will find the readme.txt (flash instructions), the sm2flash.com (BIOS flash utility) and the BIOS image (xxxxxx.rom) files. Copy these files onto a bootable floppy disk and reboot your system. It is not necessary to set BIOS boot block protection jumpers on the motherboard. At the DOS

prompt, enter the command "sm2flash." This will start the flash utility and give you an opportunity to save your current BIOS image. Flash the boot block and enter the name of the update BIOS image file. NOTE: It is important to save your current BIOS and rename it "super.rom" in case you need to recover from a failed BIOS update. Select flash boot block, then enter the update BIOS image. Select "Y" to start the BIOS flash procedure and do not disturb your system until the flash utility notifies you that the procedure is complete. After updating your BIOS, clear CMOS and then load the Optimal Values into BIOS.

Question: After flashing the BIOS, my system does not have video. How can I correct this?

Answer: If the system does not have video after flashing your new BIOS, it indicates the flashing procedure failed. To remedy this, first clear the CMOS per the instructions in this manual and retry the BIOS flashing procedure. If you still do not have video, please use the following **BIOS Recovery Procedure**. Turn your system off and place the floppy disk with the saved BIOS image file (see above FAQ) in drive A. Depress and hold "CTRL" and "Home" at the same time, then turn on the power keeping these keys depressed until your floppy drive starts reading. Your screen will remain blank until the BIOS program is done. If the system reboots correctly, the recovery was successful. The **BIOS Recovery Procedure** will not update the boot block in your BIOS.

Question: I have memory problems. What is the correct memory to use and which BIOS setting should I choose?

Answer: The correct memory to use for the SUPER S2DG2/S2DGU/S2DGE/S2DGR is 168-pin DIMMs of 3.3v non-buffered SPD (Serial Present Detection) SDRAM and SDRAM. SPD SDRAM is preferable but not essential. IMPORTANT: Please do not mix memory types; the results are unpredictable. If your memory count is exactly half of the correct value, go to the Chipset Setup in BIOS and set "SDRAM AUTOSIZING SUPPORT" to *Enabled*. Switch between the available options until one setting correctly displays your memory.

Question: Which Operating Systems (OS) supports AGP?

Answer: At present, Windows 98 and Windows NT 5.0 are the only OS that have built-in support for AGP. Some AGP video adapters can run under Windows 95 OSR2.1 with special drivers. Please contact your graphics adapter vendor for more details.

Question: Do I need the CD that came with your motherboard?

Answer: The supplied compact disc has quite a few drivers and programs that will greatly enhance your system. We recommend that you review the CD and install the applications you need. Applications included on the CD are PCI IDE Bus Master drivers for Windows 95 and Windows NT, 440GX chipset drivers for Windows 95 and 98, and the Super Doctor monitoring software.

Question: How do I install an onboard SCSI device controller for my S2DG2/S2DGU/S2DGR motherboard?

Answer: First, install the 3 NT installation disks and follow the onscreen instructions to complete the procedure. "Safe mode" is best for this installation.

Question: Why can't I turn off the power using the momentary power on/off switch?

Answer: The instant power off function is controlled by the BIOS (page 5-12). When this feature is enabled in the BIOS, the motherboard will have "instant off" capabilities as long as the BIOS has control of the system. When this feature is disabled or when the BIOS is not in control, such as during the memory count (the first screen that appears when the system is turned on), the momentary on/off switch must be held for more than four seconds to shut the system down. This feature is required to implement the ACPI features on the motherboard.

Question: I see some of my PCI devices sharing IRQs, but the system seems to be fine. Is this correct or not?

Answer: Some PCI Bus Mastering devices can share IRQs without performance penalties. These devices are designed to work correctly while sharing IRQs.

Question: When I connect my Ultra2 LVD hard drive to the JA1 SCSI connection, the drive is not recognized by BIOS or it fails to boot. Do I need a special cable?

Answer: Yes, for an Ultra2 LVD drive, you need a special 68-pin cable with active termination at the end of the cable, since Ultra2 LVD hard drives do not have a termination on the drive.

3-4 Returning Merchandise for Service

A receipt or copy of your invoice marked with the date of purchase is required before any warranty service will be rendered. You can obtain service by calling your vendor for a Returned Merchandise Authorization (RMA) number. When returning to the manufacturer, the RMA number should be prominently displayed on the outside of the shipping carton and either mailed prepaid or hand-carried. Shipping and handling charges will be applied for all orders that must be mailed when service is complete.

This warranty only covers normal consumer use and does not cover damages incurred in shipping or from failure due to the alternation, misuse, abuse or improper maintenance of products.

During the warranty period, contact your distributor first for any product problems.

Notes

Chapter 4

AMIBIOS

4-1 Introduction

This chapter describes the AMIBIOS for Intel 440GX Pentium II/III Xeon processors. The AMI ROM BIOS is stored in the Flash EEPROM and can be easily upgraded using a floppy disk-based program.

System BIOS

The BIOS is the Basic Input Output System used in all IBM® PC, XT™, AT®, and PS/2® compatible computers. WinBIOS is a high-quality example of a system BIOS.

Configuration Data

AT-compatible systems, also called ISA (Industry Standard Architecture), must have a place to store system information when the computer is turned off. The original IBM AT had 64 kbytes of non-volatile memory storage in CMOS RAM. All AT-compatible systems have at least 64 kbytes of CMOS RAM, which is usually part of the Real-Time Clock. Many systems have 128 kbytes of CMOS RAM.

How Data Is Configured

AMIBIOS provides a Setup utility in ROM that is accessed by depressing at the appropriate time during system boot. This Setup utility configures the data in CMOS RAM.

POST Memory Test

Normally, the only visible POST routine is the memory test. The screen that appears when the system is powered on is shown on the next page.

An AMIBIOS identification string is displayed at the left bottom corner of the screen, below the copyright message.

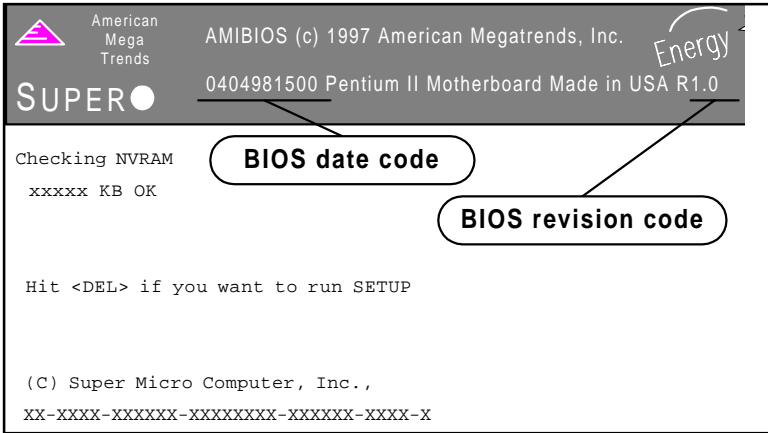

4-2 BIOS Features

- Supports Plug and Play v 1.0A and DMI 2.1
- Supports Intel PCI 2.1 (Peripheral Component Interconnect) local bus specification
- Supports Advanced Power Management (APM) Specification v 1.1
- Supports ACPI
- Supports Flash ROM

AMIBIOS supports the LS120 drive made by Matsushita-Kotobuki Electronics Industries Ltd. The LS120:

- Can be used as a boot device
- Is accessible as the next available floppy drive

AMIBIOS supports PC Health Monitoring chips. When a failure occurs in a monitored activity, AMIBIOS can sound an alarm and display a message. The PC Health Monitoring chips monitor:

- CPU temperature
- Additional temperature sensors
- Chassis intrusion detector

- Five positive voltage inputs
- Two negative voltage inputs
- Three fan speed monitor inputs

BIOS Configuration Summary Screen

AMIBIOS displays a screen that looks similar to the following when the POST routines complete successfully.

| AMIBIOS System Configuration (C) 1985-1997 American Megatrends Inc., | | | |
|--|--|---------------------------|------------|
| Main Processor | : Pentium(tm) II | Base Memory Size | : 640 KB |
| Math Processor | : Built-In | Ext. Memory Size | : 64512 KB |
| Floppy Drive A: | : 1.44 MB, 3 ¹ / ₂ | Display Type | : VGA/EGA |
| Floppy Drive B: | : None | Serial Port(s) | : 3F8, 2F8 |
| AMI-BIOS Date | : 7/15/95 | Parallel Port(s) | : 378 |
| Processor Clock | : 350MHz | External Cache | : 512 KB |
| PCI Devices | | | |
| PCI Onboard PCI Bridge | | PCI Onboard Bridge Device | |
| PCI Onboard USB Controller | | PCI Onboard IDE | |
| PCI Onboard SCSI, IRQ 10 | | PCI Onboard SCSI, IRQ 10 | |
| PCI Slot 4 VGA, IRQ 11 | | | |

*Note: The picture above reflects a board equipped with SCSI, but may be taken as a general example.

AMIBIOS Setup

See the following page for examples of the AMIBIOS Setup screen, which features options and settings. Figure 4-1 shows the **Standard** option highlighted. To highlight other options, use the arrow keys or the tab key to move to other option boxes. Figure 4-2 shows the settings for the Standard setup. Settings can be viewed by highlighting a desired option and pressing <Enter>. Use the arrow keys to choose a setting. Note: Optimal settings for all options can be set automatically. Go to the **Optimal** icon in the default box and press <Enter>. Use the arrow keys to highlight Yes, then press <Enter>.

Figure 4-1. AMIBIOS Hiflex Setup Utility Screen

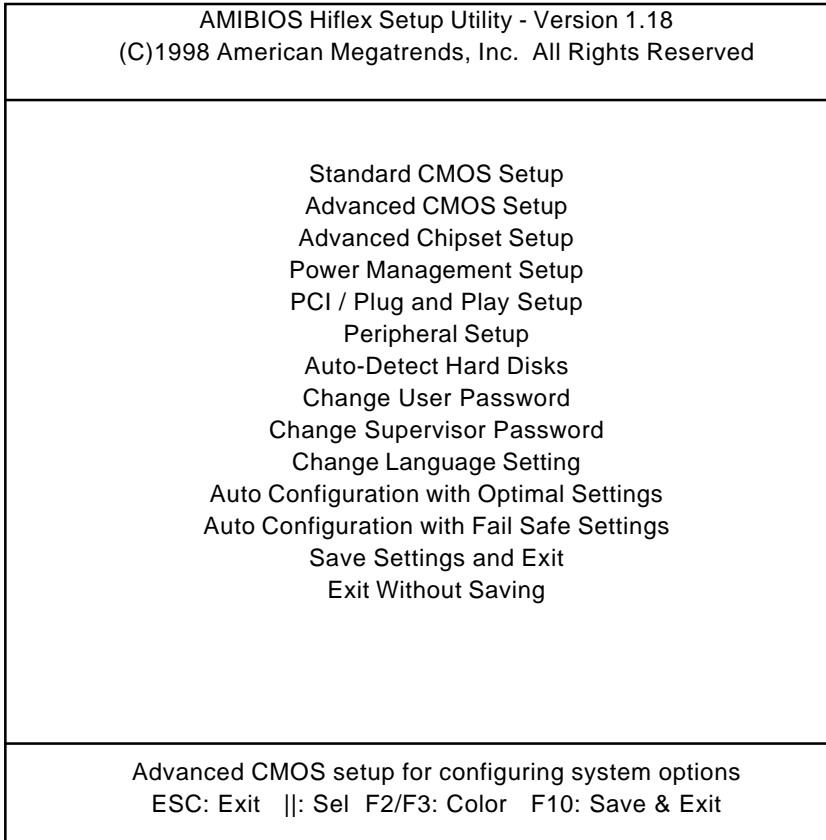

Chapter 5

Running Setup

Optimal and Fail-Safe default settings are in bold text unless otherwise noted.

The AMIBIOS Hiflex Setup options described in this section are selected by choosing the appropriate high-level icon from the Standard Setup screen. All displayed icons are described in this section, although the screen display is often all you need to understand how to set the options.

5-1 Setup

5-1-1 Standard CMOS Setup

Date and Time Configuration

Select the Standard option. Select the *Date/Time* icon. The current values for each category are displayed. Enter new values through the keyboard.

Floppy A

Floppy B

Choose the Floppy Drive A or B icon to specify the floppy drive type. The settings are *Not Installed*, *360 KB 5¼ inch*, *1.2 MB 5¼ inch*, *720 KB 3½ inch*, *1.44 MB 3½ inch* or *2.88 MB 3½ inch*. **Note: The Optimal and Fail-Safe settings for Floppy Drive A are 1.44 MB 3 1/2 inch and for Floppy Drive B are Not Installed.**

Pri Master

Pri Slave

Sec Master

Sec Slave

Select these options to configure the drive named in the option. Select *Auto Detect IDE* to let AMIBIOS automatically configure the drive. A screen with a list of drive parameters appears. Click on *OK* to configure the drive.

| Type | How to Configure |
|-------|--|
| 1-46 | Predefined types. |
| USER | Enter parameters manually. |
| AUTO | Set parameters automatically on each boot. |
| CDROM | Use for ATAPI CDROM drives. |
| ARMD | Use for LS120, MO, IOMEGA Zip drives. |

Boot Sector Virus Protection

The settings for this option are *Enabled* or *Disabled*.

Entering Drive Parameters

You can also enter the hard disk drive parameters. The drive parameters are:

| Parameter | Description |
|-----------------------|--|
| Type | The number for a drive with certain identification parameters. |
| Cylinders | The number of cylinders in the disk drive. |
| Heads | The number of heads. |
| Write Precompensation | The size of a sector gets progressively smaller as the track diameter diminishes. Yet each sector must still hold 512 bytes. Write precompensation circuitry on the hard disk compensates for the physical difference in sector size by boosting the write current for sectors on inner tracks. This parameter is the track number where write precompensation begins. |
| Sectors | The number of sectors per track. MFM drives have 17 sectors per track. RLL drives have 26 sectors per track. ESDI drives have 34 sectors per track. SCSI and IDE drive may have even more sectors per track. |
| Capacity | The formatted capacity of the drive is (Number of heads) x (Number of cylinders) x (Number of sectors per track) x (512 bytes per sector). |
| LBA Mode | Enables support for IDE Drives with capacity greater than 528 MB. |
| BLK Mode | Supports IDE Drives that use block mode. |
| PIO Mode | |
| 32-bit Mode | 32-bit transfer (should be enabled only if supported by controller). |

5-1-2 Advanced CMOS Setup

Quick Boot

The Settings are *Disabled* or *Enabled*. Set to *Enabled* to permit AMIBIOS to boot quickly when the computer is powered on. This option replaces the old Above 1 MB Memory Test Advanced Setup option. The settings are:

| <u>Setting</u> | <u>Description</u> |
|------------------------|---|
| <i>Disabled</i> | AMIBIOS tests all system memory. AMIBIOS waits for up to 40 seconds for a READY signal from the IDE hard disk drive. AMIBIOS waits for .5 seconds after sending a RESET signal to the IDE drive to allow the IDE drive time to get ready again. AMIBIOS checks for a key press and runs AMIBIOS Setup if the key has been pressed. |
| <i>Enabled</i> | AMIBIOS does not test system memory above 1 MB. AMIBIOS does not wait for up to 40 seconds for a READY signal from the IDE hard disk drive. If a READY signal is not received immediately from the IDE drive, AMIBIOS does not configure that drive. AMIBIOS does not wait for .5 seconds after sending a RESET signal to the IDE drive to allow the IDE drive time to get ready again. In <i>Enabled</i> , the keyboard will be bypassed. |

Note: You cannot run AMIBIOS Setup at system boot, because there is no delay allowing you to hit to begin the Setup routine.

Pri Master ARMD Emulated as

Pri Slave ARMD Emulated as

Sec Master ARMD Emulated as

Sec Slave ARMD Emulated as

Options for Pri Master ARMD Emulated as, Pri Slave ARMD Emulated as, Sec Master ARMD Emulated as and Sec Slave ARMD Emulated as are *Auto*, *Floppy* or *Hard disk*.

1st Boot Device

2nd Boot Device

3rd Boot Device

The options for the 1st Boot Device are *Disabled*, *1st IDE-HDD*, *2nd IDE-*

HDD, 3rd IDE-HDD, 4th IDE-HDD, Floppy, ARMD-FDD, ARMD-HDD, ATAPI CD ROM, SCSI, Network or I₂O. The options for the 2nd Boot Device are *Disabled, 1st IDE-HDD, 2nd IDE-HDD, 3rd IDE-HDD, 4th IDE-HDD, Floppy, ARMD-FDD, ARMD-HDD or ATAPI CD ROM.* The options for the 3rd Boot Device are *Disabled, 1st IDE-HDD, 2nd IDE-HDD, 3rd IDE-HDD, 4th IDE-HDD, Floppy, ARMD-FDD, ARMD-HDD or ATAPI CD ROM.*

1st IDE-HDD, 2nd IDE-HDD, 3rd IDE-HDD and 4th IDE-HDD are the four hard disks that can be installed by the BIOS. 1st IDE-HDD is the first hard disk installed by the BIOS, 2nd IDE-HDD is the second hard disk, and so on. For example, if the system has a hard disk connected to Primary Slave and another hard disk to Secondary Master, then 1st IDE-HDD will be referred to as the hard disk connected to Primary Slave and 2nd IDE-HDD will be referred to as the hard disk connected to the Secondary Master. 3rd IDE-HDD and 4th IDE-HDD are not present. Note that the order of the initialization of the devices connected to the primary and secondary channels are Primary Master first, Primary Slave second, Secondary Master third, and Secondary Slave fourth.

The BIOS will attempt to read the boot record from 1st, 2nd, 3rd and 4th boot device in the selected order until it is successful in reading the booting record. The BIOS will not attempt to boot from any device which is not selected as the boot device.

Try Other Boot Device

This option controls the action of the BIOS if all the selected boot devices failed to boot. The settings for this option are **Yes** or **No**. If **Yes** is selected and all the selected boot devices failed to boot, the BIOS will try to boot from the other boot devices (in a predefined sequence) which are present but not selected as boot devices in the setup (and hence not yet been tried for booting). If selected as **No** and all selected boot devices failed to boot, the BIOS will try not to boot from the other boot devices which may be present but not selected as boot devices in setup.

Initial Display Mode

This option determines the display screen with which the POST is going to start the display. The settings for this option are **BIOS** or **Silent**. If selected as **BIOS**, the POST will start with the normal sign-on message screen. If **Silent** is selected, the POST will start with the silent screen.

Display Mode at Add-on ROM Init

This option determines the display mode during add-on ROM (except Video add-on ROM) initialization. The settings for this option are **Force BIOS** or

Keep Current. If selected as *Force BIOS*, the POST will force the display to be changed to BIOS mode before giving control to any add-on ROM. If no add-on ROM is found, then the current display mode will remain unchanged even if this setup question is selected as *Force BIOS*. If selected as *Keep Current*, then the current display mode will remain unchanged.

Floppy Access Control

The settings for this option are ***Read-Write*** or ***Read-Only***.

Hard Disk Access Control

The settings for this option are ***Read-Write*** or ***Read-Only***.

S.M.A.R.T. for Hard Disks

S.M.A.R.T. (Self-Monitoring, Analysis and Reporting Technology) is a technology developed to manage the reliability of the hard disk by predicting future device failures. The hard disk needs to be S.M.A.R.T. capable. The settings for this option are ***Disabled*** or ***Enabled***. ****Note: S.M.A.R.T. cannot predict all future device failures. S.M.A.R.T. should be used as a warning tool, not as a tool to predict the device reliability.***

Boot Up Num-Lock

Settings for this option are ***On*** or ***Off***. When this option is set to ***On***, the BIOS turns off the Num Lock key when the system is powered on. This will enable the end user to use the arrow keys on both the numeric keypad and the keyboard.

PS/2 Mouse Support

Settings for this option are ***Enabled*** or ***Disabled***. When this option is set to ***Enabled***, AMIBIOS supports a PS/2-type mouse.

Primary Display

This option specifies the type of display adapter card installed in the system. The settings are ***Absent***, ***VGA/EGA***, ***CGA40x25***, ***CGA80x25*** or ***Mono***.

Password Check

This option enables the password check option every time the system boots or the end user runs WinBIOS Setup. If ***Always*** is chosen, a user password prompt appears every time the computer is turned on. If ***Setup*** is chosen, the password prompt appears if WinBIOS Setup is executed.

Boot to OS/2

If DRAM size is over 64 MB, set this option to ***Yes*** to permit AMIBIOS to run with IBM OS/2. The settings are ***No*** or ***Yes***.

CPU Microcode Updation

Set this option to *Enabled* to permit the CPU to be updated on line. The settings for this option are **Enabled** or *Disabled*.

Internal Cache

This option is for enabling or disabling the internal cache memory. The settings for this option are *Disabled*, *Write-thru* or **WriteBack**.

System BIOS Cacheable

When set to *Enabled*, the contents of the F0000h system memory segment can be read from or written to cache memory. The contents of this memory segment are always copied from the BIOS ROM to system RAM for faster execution. The settings are *Enabled* or *Disabled*. **Note: The Optimal default setting is Enabled and the Fail-Safe default setting is Disabled. Set this option to Enabled to permit the contents of F0000h RAM memory segment to be written to and read from cache memory.**

CPU ECC

The settings for this option are **Enabled** or *Disabled*. This option enables Pentium II L2 cache ECC function.

MPS Revision 1.4

The settings for this option are *1.1* or **1.4**.

C000, 16K Shadow

C400, 16K Shadow

These options specify how the 32 KB of video ROM at C0000h is treated. The settings are: *Disabled*, *Enabled* or **Cached**. When set to *Disabled*, the contents of the video ROM are not copied to RAM. When set to *Enabled*, the contents of the video ROM area from C0000h-C7FFFh are copied (shadowed) from ROM to RAM for faster execution. When set to *Cached*, the contents of the video ROM area from C0000h-C7FFFh are copied from ROM to RAM, and can be written to or read from cache memory.

C000, 16K Shadow

C400, 16K Shadow

D800, 16K Shadow

CC00, 16K Shadow

D400, 16K Shadow

D800, 16K Shadow

DC00, 16K Shadow

These options enable shadowing of the contents of the ROM area named in the option. The ROM area not used by ISA adapter cards is allocated to PCI

adapter cards. The settings are: **Disabled**, **Enabled** or **Cached**. When set to **Disabled**, the contents of the video ROM are not copied to RAM. When set to **Enabled**, the contents of the video ROM area from C0000h-C7FFFh are copied (shadowed) from ROM to RAM for faster execution. When set to **Cached**, the contents of the video ROM area from C0000h-C7FFFh are copied from ROM to RAM and can be written to or read from cache memory.

5-1-3 Advanced Chipset Setup

USB Function

The settings for this option are **Enabled** or **Disabled**. Set this option to **Enabled** to enable the USB (Universal Serial Bus) functions.

USB KB/Mouse Legacy Support

The settings for this option are **Keyboard**, **Auto**, **Keyboard+Mouse** or **Disabled**. Set this option to **Enabled** to enable the USB keyboard and mouse.

Port 64/60 Emulation

The settings for this option are **Enabled** or **Disabled**.

SERR# (System Error)

The settings for this option are **Enabled** or **Disabled**. Set to **Enabled** to enable the SERR# signal on the bus. GX asserts this signal to indicate a system error condition. SERR# is asserted under the following conditions:

- In an ECC configuration, the GX asserts SERR#, for single bit (correctable) ECC errors or multiple bit (non-correctable) ECC errors if SERR# signaling is enabled via the ERRCMD control register. Any ECC errors received during initialization should be ignored.
- The GX asserts SERR# for one clock when it detects a target abort during GX initiated PCI cycle
- The GX can also assert SERR# when a PCI parity error occurs during the address or data phase
- The GX can assert SERR# when it detects a PCI address or data parity error on AGP
- The GX can assert SERR# upon detection of access to an invalid entry in the Graphics Aperture Translation Table
- The GX can assert SERR# upon detecting an invalid AGP master access outside of AGP aperture and outside of main DRAM range (i.e. in the 640k - 1M range or above TOM)
- The GX can assert SERR# upon detecting an invalid AGP master access outside of AGP aperture.
- The GX asserts SERR# for one clock when it detects a target abort during GX initiated AGP cycle

PERR#

The settings for this option are *Enabled* or *Disabled*. Set to *Enabled* to enable the PERR# signal on the bus.

WSC# Handshake (Write Snoop Complete)

This signal is asserted active to indicate that all the snoop activity on the CPU bus on the behalf of the last PCI-DRAM write transaction is complete and that it is safe to send the APIC interrupt message. The settings for this option are *Enabled* or *Disabled*. Set to *Enabled* to enable handshaking for the WSC# signal.

USWC Write Post

The settings for this option are *Enabled* or *Disabled*. This option sets the status of USWC (Uncacheable, Speculatable, Write-Combined) posted writes. Set to *Enabled* to enable USWC posted writes to I/O. Set to *Disabled* to disable USWC posted writes to I/O.

GX Master Latency Timer (CLKs)

This option specifies the master latency timings (in PCI clocks) for devices in the computer. The settings are *Disabled*, 32, **64**, 96, 128, 160, 192 or 224.

Multi-Trans Timer (Clks)

This option specifies the multi-trans latency timings (in PCI clocks) for devices in the computer. The settings are *Disabled*, **32**, 64, 96, 128, 160, 192 or 224.

PCI1 to PCI0 Access

The settings for this option are *Enabled* or *Disabled*. Set to *Enabled* to enable access between two different PCI buses (PCI1 and PCI0).

Memory Autosizing Support

The dynamic detection and sizing of SDRAM and EDO is performed by the BIOS in a system populated with memory which has no SPD information. When set to *Enable*, memory does not have the SPD information. The settings for this option are *Auto* or *Enable*.

DRAM Integrity Mode

The settings for this option are *None*, *EC* or *ECC Hardware*. **Note: For ECC memory only. See the table below to set the type of system memory checking.**

| <u>Setting</u> | <u>Description</u> |
|-------------------------|---|
| None | No error checking or error reporting is done. |
| EC | Multibit errors are detected and reported as parity errors. Single-bit errors are corrected by the chipset. Corrected bits of data from memory are not written back to DRAM system memory. |
| ECC Hardware | Multibit errors are detected and reported as parity errors. Single-bit errors are corrected by the chipset and are written back to DRAM system memory. If a soft (correctable) error occurs, writing the fixed data back to DRAM system memory will resolve the problem. Most DRAM errors are soft errors. If a hard (uncorrectable) error occurs, writing the fixed data back to DRAM system memory does not solve the problem. In this case, the second time the error occurs in the same location, a Parity Error is reported, indicating an uncorrectable error. If ECC is selected, AMIBIOS automatically enables the System Management Interface (SMI). If you do not want to enable power management, set the Power Management/APM option to <i>Disabled</i> and set all Power Management Setup timeout options to <i>Disabled</i> . To enable power management, set Power Management/APM to <i>Enabled</i> and set the power management timeout options as desired. |

DRAM Refresh Rate

This option specifies the interval between Refresh signals to DRAM system memory. The settings for this option are **15.6 us** (micro-seconds), *31.2 us*, *62.4 us*, *124.8 us* or *249.6 us*.

Memory Hole

This option specifies the location of an area of memory that cannot be addressed on the ISA bus. The settings are **Disabled**, *15 MB-16 MB*, or *512 KB-640 KB*.

SDRAM CAS# Latency

This option regulates the column address strobe. The settings are 2 SCLKs, 3 SCLKs or **Auto**.

SDRAM RAS# to CAS# Delay

This option specifies the length of the delay inserted between the RAS and CAS signals of the DRAM system memory access cycle if SDRAM is installed. The settings are *Auto* (AMIBIOS automatically determines the optimal delay), *2 SCLKs* or *3 SCLKs*. **Note: The Optimal default setting is *Auto* and the Fail-Safe default setting is *3 SCLKs*.**

SDRAM RAS# Precharge

This option specifies the length of the RAS precharge part of the DRAM system memory access cycle when Synchronous DRAM system memory is installed in the computer. The settings are *Auto* (AMIBIOS automatically determines the optimal delay), *2 SCLKs* or *3 SCLKs*. **Note: The Optimal default setting is *Auto* and the Fail-Safe default setting is *3 SCLKs*.**

Power Down SDRAM

BX supports SDRAM power down mode to minimize SDRAM power usage. The settings for this option are *Enabled* or *Disabled*. The *Enabled* setting enables the SDRAM Power Down feature.

ACPI Control Register

The settings for this option are *Enabled* or *Disabled*. Set this option to *Enabled* to enable the ACPI (Advanced Configuration and Power Interface) control register.

Gated Clock

Signal GCLKEN enables internal dynamic clock gating in the GX when a AGPset "IDLE" state occurs. This happens when the GX detects an idle state on all its buses. The settings for this option are *Enabled* or *Disabled*. The *Enabled* setting enables the gated clock.

Graphics Aperture Size

This option specifies the amount of system memory that can be used by the Accelerated Graphics Port (AGP). The settings are *4 MB*, *8 MB*, *16 MB*, *32 MB*, *64 MB*, *128 MB*, or *256 MB*.

Search for MDA (Monochrome Adapter) Range (B0000h-B7FFFh) Resources

Legacy support requires the ability to have a second graphics controller (monochrome) in the system. In an AGP system, accesses in the normal VGA range are forwarded to the AGP bus. Since the monochrome adapter may be on the PCI (or ISA) bus, the GX must decode cycles in the MDA range and forward them to PCI. The settings for this option are *Yes* or *No*. Set this option to *Yes* to let AMIBIOS search for MDA resources.

AGP Multi-Trans Timer (AGP Clks)

This option sets the AGP multi-trans timer. The settings are in units of AGP clocks: **32**, 64, 96, 128, 160, 192, or 224.

AGP Low-Priority Timer

This option controls the minimum tenure on the AGP for low priority data transaction for both read and write. The settings are *Disabled*, **16**, 32, 64, 96, 128, 160, 192 or 224.

AGP SERR (Advanced Graphic Port System Error)

GX asserts this signal to indicate a AGP system error condition. The settings for this option are *Enabled* or **Disabled**. Set to *Enabled* to enable the AGP SERR# signal.

AGP Parity Error Response

The settings for this option are *Enabled* or **Disabled**. Set to *Enabled* to enable the AGP (Accelerated Graphics Port) to respond to parity errors.

8bit I/O Recovery Time

This option specifies the length of a delay inserted between consecutive 8-bit I/O operations. The settings are **Disabled**, 8 SYSCCLKs, 1 SYSCCLK, 2 SYSCCLKs, 3 SYSCCLKs, 4 SYSCCLKs, 5 SYSCCLKs or 6 SYSCCLKs.

16bit I/O Recovery Time

This option specifies the length of a delay inserted between consecutive 16-bit I/O operations. The settings are **Disabled**, 3 SYSCCLK, 1 SYSCCLKs, 2 SYSCCLKs or 4 SYSCCLKs.

PIIX4 SERR#

This signal is asserted to indicate a PIIX4 System Error condition. The settings for this option are *Enabled* or **Disabled**. The *Enabled* option enables the SERR# signal for the Intel PIIX4 chip.

USB Passive Release

GX releases USB bus when it is idle to maximize the USB bus usage. The settings for this option are **Enabled** or *Disabled*. Set this option to *Enabled* to enable passive release for USB.

PIIX4 Passive Release

This option functions similarly to USB Passive Release. The settings for this option are **Enabled** or *Disabled*. Set to *Enabled* to enable passive release for the Intel PIIX4 chip.

PIIX4 Delayed Transaction

GX is capable of PIIX4 transaction to improve PIIX4 interrupt efficiency. The settings for this option are **Enabled** or **Disabled**. Set this option to **Enabled** to enable delayed transactions for the Intel PIIX4 chip.

Type F DMA Buffer Control1

Type F DMA Buffer Control2

These options specify the DMA channel where Type F buffer control is implemented. The settings are **Disabled**, **Channel 1-0**, **Channel 1-1**, **Channel 1-2**, **Channel 1-3**, **Channel 1-4**, **Channel 1-5**, **Channel 1-6** or **Channel 1-7**.

DMA0 Type

DMA1 Type

DMA2 Type

DMA3 Type

DMA4 Type

DMA5 Type

DMA6 Type

DMA7 Type

These options specify the bus that the specified DMA channel can be used on. The settings are **PC/PCI**, **Distributed**, or **Normal ISA**.

Memory Buffer Strength

The settings for this option are **Strong**, **Medium** or **Auto**.

Manufacturer's Setting

Note: The user should always set this option to mode 0. All other modes are for factory testing only.

5-1-4 Power Management Setup

Power Management/APM

The settings for this feature are: **APM**, **ACPI** or **Disabled**. Set to **APM** to enable the power conservation feature specified by Intel and Microsoft INT 15h Advance Power Management BIOS functions. Set to **ACPI** if your operating system supports Microsoft's Advanced Configuration and Power Interface (ACPI) standard.

Power Button Function

This option specifies how the power button mounted externally on the computer chassis is used. The settings are: **Suspend** or **On/Off**. When set

to *On/Off*, pushing the power button turns the computer on or off. When set to *Suspend*, pushing the power button places the computer in Suspend mode or Full On power mode.

Green PC Monitor Power State

This option specifies the power state that the green PC-compliant video monitor enters when AMIBIOS places it in a power savings state after the specified period of display inactivity has expired. The settings are *Standby*, *Suspend* or *Off*. **Note: The Optimal default setting for this option is *Suspend* and the Fail-Safe setting is *Standby*.**

Video Power Down Mode

This option specifies the power conserving state that the VGA video subsystem enters after the specified period of display inactivity has expired. The settings are *Disabled*, *Standby*, or *Suspend*. **Note: The Optimal default setting for this option is *Suspend* and the Fail-Safe default setting is *Disabled*.**

Hard Disk Power Down Mode

This option specifies the power conserving state that the hard disk drive enters after the specified period of hard drive inactivity has expired. The settings are *Disabled*, *Standby*, or *Suspend*. **Note: The Optimal default setting for this option is *Suspend* and the Fail-Safe default setting is *Disabled*.**

Hard Disk Timeout (Minutes)

This option specifies the length of a period of hard disk drive inactivity. When this length of time expires, the computer enters power-conserving state specified in the Hard Disk Power Down Mode option. The settings are ***Disabled*** and *1 Min through 15 Min in 1 minute intervals*.

Power Saving Type

The settings for this option are ***Sleep***, *Stop Clock* or *Deep Sleep*.

Standby/Suspend Timer Unit

This allows you to set the standby timeout and suspend timeout timer unit. The settings are *32 secs*, *4 msec*s, ***4 min*** or *4 secs*.

Standby Timeout

This option specifies the length of a period of system inactivity while in full power on state. When this length of time expires, the computer enters standby power state. The settings are ***Disabled*** and *4 Min through 508 Min in 4 minute intervals*.

Suspend Timeout (Minutes)

This option specifies the length of a period of system inactivity while in standby state. When this length of time expires, the computer enters suspend power state. The settings are **Disabled** and *4 Min through 508 Min in 4 minute intervals*.

Slow Clock Ratio

The value of the slow clock ratio indicates the percentage of time the STPCLK# signal is asserted while in the thermal throttle mode. The settings are *Disabled, 0-12.5%, 12.5-25%, 25-37.5%, 37.5-50%, 50-62.5%, 62.5-75%, or 75-87.5%*.

Display Activity

This option specifies if AMIBIOS is to monitor display activity for power conservation purposes. When this option is set to *Monitor* and there is no display activity for the length of time specified in the Standby Timeout (Minute) option, the computer enters a power savings state. The settings are *Monitor* or **Ignore**.

Device 6 (Serial port 1)

Device 7 (Serial port 2)

Device 8 (Parallel port)

Device 5 (Floppy disk)

Device 0 (Primary Master IDE)

Device 1 (Primary Slave IDE)

Device 2 (Secondary Master IDE)

Device 3 (Secondary Slave IDE)

When set to *Monitor*, these options enable event monitoring on the specified hardware interrupt request line. If set to *Monitor* and the computer is in a power saving state, AMIBIOS watches for activity on the specifies IRQ line. The computer enters the Full On state if any activity occurs. AMIBIOS reloads the Standby and Suspend timeout timers if activity occurs on the specified IRQ line. **Note: The Optimal default setting for each option is Ignore with the exception of Devices 0 (Primary Master IDE) and 6 (Serial Port 1) which should be set to Monitor. The Fail-Safe default for each option is Monitor.**

LAN Wake-Up

RTC Wake-UP

Options for LAN Wake-Up and RTC Wake-Up are **Disabled** or *Enabled*. When enabled, the **Hour** and **Minute** functions become available.

5-1-5 PCI/PnP Setup

Plug and Play-Aware OS

The settings for this option are **No** or **Yes**. Set this option to **Yes** if the operating system in the computer is aware of and follows the Plug and Play specification. AMIBIOS only detects and enables PnP ISA adapter cards that are required for system boot. Currently, only Windows 95 is PnP-Aware. Set this option to **No** if the operating system (such as DOS, OS/2, Windows 3.x) does not use PnP. You must set this option correctly. Otherwise, PnP-aware adapter cards installed in the computer will not be configured properly.

PCI Latency Timer (PCI Clocks)

This option specifies the latency timings in PCI clocks for all PCI devices. The settings are 32, **64**, 96, 128, 160, 192, 224, or 248.

PCI VGA Palette Snoop

The settings for this option are **Disabled** or **Enabled**. When set to **Enabled**, multiple VGA devices operating on different buses can handle data from the CPU on each set of palette registers on every video device. Bit 5 of the command register in the PCI device configuration space is the VGA Palette Snoop bit (0 is disabled). For example: if there are two VGA devices in the computer (one PCI and one ISA) and this option is disabled, data read and written by the CPU is only directed to the PCI VGA device's palette registers. If enabled, data read and written by the CPU is directed to both the PCI VGA device's palette registers and the ISA VGA palette registers. This will permit the palette registers of both devices to be identical. This option must be set to **Enabled** if any ISA adapter card installed in the system requires VGA palette snooping.

PCI IDE Busmaster

The settings for this option are **Disabled** or **Enabled**. Set to **Enabled** to specify the IDE Controller on the PCI bus has bus mastering capabilities. Under Windows 95, you should set this option to **Disabled** and install the Bus Mastering driver.

Offboard PCI IDE Card

This option specifies if an offboard PCI IDE controller adapter card is installed in the computer. The PCI expansion slot on the motherboard where the offboard PCI IDE controller is installed must be specified. If an offboard PCI IDE controller is used, the onboard IDE controller is automatically disabled. The settings are **Auto** (AMIBIOS automatically determines where the offboard PCI IDE controller adapter card is installed), *Slot 1*, *Slot 2*, *Slot 3*, *Slot 4*, *Slot 5* or *Slot 6*.

This option forces IRQ14 and IRQ15 to a PCI slot on the PCI local bus. This is necessary to support non-compliant ISA IDE controller adapter cards. If an offboard PCI IDE controller adapter card is installed in the computer, you must also set the Offboard PCI IDE Primary IRQ and Offboard PCI IDE Secondary IRQ options.

Offboard PCI IDE Primary IRQ

Offboard PCI IDE Secondary IRQ

These options specify the PCI interrupt used by the primary (or secondary) IDE channel on the offboard PCI IDE controller. The settings are **Disabled**, **Hardwired**, **INTA**, **INTB**, **INTC**, or **INTD**.

PCI Slot1 IRQ Priority

PCI Slot2 IRQ Priority

PCI Slot3 IRQ Priority

PCI Slot4 IRQ Priority

These options specify the IRQ priority for PCI devices installed in the PCI expansion slots. The settings are **Auto**, (*IRQ*) **3, 4, 5, 7, 9, 10, 11, 12 or 14** in priority order.

DMA Channel 0

DMA Channel 1

DMA Channel 3

DMA Channel 5

DMA Channel 6

DMA Channel 7

These DMA channels control the data transfers between the I/O devices and the system memory. The chipset allows the BIOS to choose which channels to do the job. The settings are **PnP** or **ISA/EISA**.

IRQ3

IRQ4

IRQ5

IRQ7

IRQ9

IRQ10

IRQ11

IRQ12

IRQ14

IRQ15

These options specify which bus the specified IRQ line is used on and allow you to reserve IRQs for legacy ISA adapter cards. If more IRQs must be

removed from the pool, the end user can use these options to reserve the IRQ by assigning an *ISA/EISA* setting to it. Onboard I/O is configured by AMIBIOS. All IRQs used by onboard I/O are configured as PCI/PnP.

IRQ14 and 15 will not be available if the onboard PCI IDE is enabled. If all IRQs are set to *ISA/EISA* and IRQ14 and 15 are allocated to the onboard PCI IDE, IRQ 9 will still be available for PCI and PnP devices. This is because at least one IRQ must be available for PCI and PnP devices. The settings are **PCI/PnP** or *ISA/EISA*.

Reserved Memory Size

This option specifies the size of the memory area reserved for legacy ISA adapter cards. The settings are **Disabled**, *16K*, *32K* or *64K*.

Reserved Memory Address

This option specifies the beginning address (in hex) of the reserved memory area. The specified ROM memory area is reserved for use by legacy ISA adapter cards. The settings are *C000*, *C400*, **C800**, *CC00*, *D000*, *D400*, *D800* or *DC00*.

PCI Device Search Order

The settings for this option are **First-Last** or *Last-First*.

Default Primary Video

This feature supports multiple displays. The settings are **AGP** or *PCI*.

5-1-6 Peripheral Setup

On-board SCSI

The settings for this option are **Enabled** or *Disabled*. When set to *Enable* this option enables the Adaptec 7895 BIOS on the P6DGS motherboard or the Adaptec 7890 on the P6DGU/P6SGU motherboards.

Remote Power On

Microsoft's Memphis OS supports this feature which can wake-up the system from SoftOff state through devices (such as an external modem) that are connected to COM1 or COM2. The settings are **Disabled** or *Enabled*.

System Current Temperature

The current system temperature is displayed in this option.

System Overheat Warning

The settings for this option are **Enabled** or **Disabled**. When set to **Enabled**, this option allows the user to set an overheat warning temperature.

Set Overheat Warning Temperature

Use this option to set the overheat warning temperature. The settings are *25°C through 99°C in 1°C intervals*. **Note: The Optimal and Fail-Safe default settings are 63°C.**

H/W Monitor In0 (CPU 1)

H/W Monitor In1 (CPU 2)

H/W Monitor In2 (+3.3V)

H/W Monitor In3 (+5V)

H/W Monitor In4 (+12V)

H/W Monitor In5 (-12V)

H/W Monitor In6 (-5V)

CPU1 Fan

CPU2 Fan

Thermal Control Fan

The above features are for PC Health Monitoring. The motherboards with W83781D have seven on-board voltage monitors for the CPU core, CPU I/O, +3.3V, +5V, -5V, +12V, and -12V, and three fan status monitors.

On-Board FDC

This option enables the FDC (Floppy Drive Controller) on the motherboard. The settings are **Disabled**, or **Enabled**.

On-Board Serial Port A

This option specifies the base I/O port address of serial port 1. The settings are **Auto** (AMIBIOS automatically determines the correct base I/O port address), **Disabled**, **3F8h/COM1**, **2F8h/COM2**, **3E8h/COM3** or **2E8h/COM4**.

On-Board Serial Port B

This option specifies the base I/O port address of serial port 2. The settings are **Auto** (AMIBIOS automatically determines the correct base I/O port address), **Disabled**, **3F8h/COM1**, **2F8h/COM2**, **3E8h/COM3** or **2E8h/COM4**.

Serial Port B Mode

The settings for this option are **Normal**, **IrDA** or **ASK IR**. When set to **IrDA**, the IR Duplex Mode becomes available and can be set to either Half or Full. When set to **ASK IR**, the IrDA Protocol becomes available and can be set to 1.6 us or 3/16.

On-Board Parallel Port

This option specifies the base I/O port address of the parallel port on the motherboard. The settings are *Auto* (AMIBIOS automatically determines the correct base I/O port address), *Disabled*, **378**, **278** or **3BC**.

Parallel Port Mode

This option specifies the parallel port mode. The settings are *Normal*, *Bi-Dir*, *EPP* or *ECP*. When set to *Normal*, the normal parallel port mode is used. Use *Bi-Dir* to support bidirectional transfers. Use *EPP* (Enhanced Parallel Port) to provide asymmetric bidirectional data transfer driven by the host device. Use *ECP* (Extended Capabilities Port) to achieve data transfer rates of up to 2.5 Mbps. ECP uses the DMA protocol and provides symmetric bidirectional communication. **Note: The Optimal default setting for this option is Bi-Dir and the Fail-Safe setting is Normal.**

EPP Version

The settings are *1.7* or *1.9*. **Note: The Optimal and Fail-Safe default settings are N/A.**

Parallel Port IRQ

This option specifies the IRQ to be used by the parallel port. The settings are *5* or *7*.

Parallel Port DMA Channel

This option is only available if the setting of the parallel port mode option is *ECP*. The settings are *0*, *1*, *2*, *3*, *5*, *6* or *7*. **Note: This option is N/A.**

On-Board IDE

This option specifies the onboard IDE controller channels to be used. The settings are *Disabled*, *Primary*, *Secondary* or **Both**.

5-2 Auto Detect Hard Disks

Date and Time Configuration

The current values for each category are displayed. Enter new values through the keyboard.

Floppy A**Floppy B**

Choose the Floppy Drive A or B icon to specify the floppy drive type. The setting for Floppy Drive A is **1.44 MB 3 1/2 inch** and for Floppy Drive B is **Not Installed**.

Pri Master

Pri Slave

Sec Master

Sec Slave

Select these options to configure the drive named in the option. The setting for Primary Master and Secondary Slave is **Auto**. The Primary Slave and Secondary Master are **Not-Installed**.

5-3 Change User Password Change Supervisor Password

The system can be configured so that all users must enter a password every time the system boots or when the AMIBIOS Hiflex setup is executed. You can set either a Supervisor password or a User password. If you do not want to use a password, just press <Enter> when the password prompt appears.

The password check option is enabled in the Advanced Setup by choosing either *Always* or *Setup*. The password is stored in CMOS RAM. You can enter a password by typing the password on the keyboard, selecting each letter via the mouse, or selecting each letter via the pen stylus. Pen access must be customized for each specific hardware platform.

When you select Supervisor or User, AMIBIOS prompts for a password. You must set the Supervisor password before you can set the User password. Enter a 1-6 character password. The password does not appear on the screen when typed. Retype the new password as prompted and press <Enter>. Make sure you write it down. If you forget it, you must drain CMOS RAM and reconfigure.

5-4 Change Language Setting

Note: The Optimal and Fail-Safe default settings for this option are English.

5-5 Default Settings

Every option in AMIBIOS Hiflex Setup contains two default settings: a Fail-Safe default, and an Optimal default.

5-5-1 Auto Configuration with Optimal Settings

The Optimal default settings provide optimum performance settings for all devices and system features.

5-5-2 Auto Configuration with Fail-Safe Settings

The Fail-Safe default settings consist of the safest set of parameters. Use them if the system is behaving erratically. They should always work but do not provide optimal system performance characteristics.

Notes

Appendix A

BIOS Error Beep Codes & Messages

During the POST (Power-On Self-Test) routines, which are performed each time the system is powered on, errors may occur.

Non-fatal errors are those which, in most cases, allow the system to continue the boot-up process. The error messages normally appear on the screen.

Fatal errors are those which will not allow the system to continue the boot-up procedure. If a fatal error occurs, you should consult with your system manufacturer for possible repairs.

These fatal errors are usually communicated through a series of audible beeps. On the following page, the numbers on the fatal error list correspond to the number of beeps for the corresponding error. All errors listed, with the exception of #8, are fatal errors.

| Beeps | Error message | Description |
|-------|---|--|
| 1 | Refresh Failure | The memory refresh circuitry on the motherboard is faulty. |
| 2 | Parity Error | A parity error was detected in the base memory (the first 64 KB block) of the system. |
| 3 | Base 64 KB Memory Failure | A memory failure occurred within the first 64 KB of memory. |
| 4 | Timer Not Operational | A memory failure was detected in the first 64 KB of memory, or Timer 1 is not functioning. |
| 5 | Processor Error | The CPU on the system board generated an error. |
| 6 | 8042 - Gate A20 Failure | The keyboard controller (8042) contains the Gate A20 switch which allows the CPU to operate in virtual mode. This error means that the BIOS cannot switch the CPU into protected mode. |
| 7 | Processor Exception Interrupt Error | The CPU on the motherboard generated an exception interrupt. |
| 8 | Display Memory Read/Write Error | The system video adapter is either missing or its memory is faulty. Please Note: This is not a fatal error. |
| 9 | ROM Checksum Error | The ROM checksum value does not match the value encoded in the BIOS. |
| 10 | CMOS Shutdown Register Read/Write Error | The shutdown register for CMOS memory has failed. |

Refer to the table on page A-3 for solutions to the error beep codes.

Appendix A: BIOS Error Beep Codes

| If it beeps... | then ... |
|------------------------|--|
| 1, 2 or 3 times | reseat the DIMM memory. If the system still beeps, replace the memory. |
| 6 times | reseat the keyboard controller chip. If it still beeps, replace the keyboard controller. If it still beeps, try a different keyboard, or replace the keyboard fuse, if the keyboard has one. |
| 8 times | there is a memory error on the video adapter. Replace the video adapter or the RAM on the video adapter. |
| 9 times | the BIOS ROM chip is bad. The system probably needs a new BIOS ROM chip. |
| 4, 5, 7 or 10 times | the motherboard must be replaced. |

| Error Message | Information |
|----------------------------|--|
| 8042 Gate -- A20 Error | Gate A20 on the keyboard controller (8042) is not working. Replace the 8042. |
| Address Line Short! | Error in the address decoding circuitry on the motherboard. |
| C: Drive Error | Hard disk drive C: does not respond. Run the Hard Disk Utility to correct this problem. Also, check the C: hard disk type in Standard Setup to make sure that the hard disk type is correct. |
| C: Drive Failure | Hard disk drive C: does not respond. Replace the hard disk drive. |
| Cache Memory Bad | Cache memory is defective. Replace it. Do Not Enable Cache! |
| CH-2 Timer Error | Most ISA computers include two timers. There is an error in time 2. |
| CMOS Battery State Low | CMOS RAM is powered by a battery. The battery power is low. Replace the battery. |
| CMOS Checksum Failure | After CMOS RAM values are saved, a checksum value is generated for error checking. The previous value is different from the current value. Run WINBIOS Setup or AMIBIOS Setup. |
| CMOS System Option Not Set | The values stored in CMOS RAM are either corrupt or nonexistent. Run WINBIOS Setup or AMIBIOS Setup. |
| CMOS Display Type Mismatch | The video type in CMOS RAM does not match the type detected by the BIOS. Run WINBIOS Setup or AMIBIOS Setup. |
| CMOS Memory Size Mismatch | The amount of memory on the motherboard is different than the amount in CMOS RAM. Run WINBIOS Setup or AMIBIOS Setup. |

Appendix A: BIOS Error Beep Codes

| Error Message | Information |
|----------------------------|---|
| CMOS Time and Date Not Set | Run Standard Setup to set the date and time in CMOS RAM. |
| D: Drive Error | Hard disk drive D: does not respond. Run the Hard Disk Utility. Also check the D: hard disk type in Standard Setup to make sure that the hard disk drive type is correct. |
| D: Drive Failure | Hard disk drive D: does not respond. Replace the hard disk. |
| Diskette Boot Failure | The boot disk in floppy drive A: is corrupt. It cannot be used to boot the computer. Use another boot disk and follow the on-screen instructions. |
| Display Switch Not Proper | Some computers require a video switch on the motherboard be set to either color or monochrome. Turn the computer off, set the switch, then power on. |
| DMA Error | Error in the DMA controller. |
| DMA #1 Error | Error in the first DMA channel. |
| DMA #2 Error | Error in the second DMA channel. |
| FDD Controller Failure | The BIOS cannot communicate with the floppy disk drive controller. Check all appropriate connections after the computer is powered down. |
| HDD Controller Failure | The BIOS cannot communicate with the hard disk drive controller. Check all appropriate connections after the computer is powered down. |
| INTR #1 Error | Interrupt channel 1 failed POST. |
| INTR #2 Error | Interrupt channel 2 failed POST. |

| Error Message | Information |
|------------------------------------|---|
| Invalid Boot Diskette | The BIOS can read the disk in floppy drive A:, but cannot boot the computer. Use another boot disk. |
| Keyboard Is Locked... Unlock It | The keyboard lock on the computer is engaged. The computer must be unlocked to continue. |
| Keyboard Error | There is a timing problem with the keyboard. Set the <i>Keyboard</i> options in Standard Setup to <i>Not Installed</i> to skip the keyboard post routines. |
| KB/Interface Error | There is an error in the keyboard connector. |
| No ROM BASIC | Cannot find a bootable sector on either disk drive A: or hard disk drive C:. The BIOS calls INT 18h, which generates this message. Use a bootable disk. |
| Off Board Parity Error | Parity error in memory installed in an expansion slot. The format is: OFF BOARD PARITY ERROR ADDR (HEX) = (XXXX) XXXX is the hex address where the error occurred. Run AMIDdiag to find and correct memory problems. |
| On Board Parity Error | Parity error in motherboard memory. The format is: ON BOARD PARITY ERROR ADDR (HEX) = (XXXX) XXXX is the hex address where the error occurred. Run AMIDdiag to find and correct memory problems. |
| Parity Error???? | Parity error in system memory at an unknown address. Run AMIDdiag to find and correct memory problems. |

Appendix B

AMIBIOS POST Diagnostic Error Messages

This section describes the power-on self-tests (POST) port 80 codes for the AMI BIOS.

Check

Point Description

| | |
|----|---|
| 00 | Code copying to specific areas is done. Passing control to INT 19h boot loader next. |
| 03 | NMI is Disabled. Next, checking for a soft reset or a power-on condition. |
| 05 | The BIOS stack has been built. Next, disabling cache memory. |
| 06 | Uncompressing the post code unit next. |
| 07 | Next, initializing the CPU init and the CPU data area. |
| 08 | The CMOS checksum calculation is done next. |
| 0B | Next, performing any required initialization before keyboard BAT command is issued. |
| 0C | The keyboard controller I/B is free. Next, issuing the BAT command to the keyboard controller. |
| 0E | The keyboard controller BAT command result has been verified. Next, performing any necessary initialization after the keyboard controller BAT command test. |
| 0F | The initialization after the keyboard controller BAT command test is done. The keyboard command byte is written next. |

Check

PointDescription

- 10 The keyboard controller command byte is written. Next, issuing the pin 23 and 24 blocking and unblocking commands.

- 11 Next, checking if the <End or <Ins> keys were pressed during power on. Initializing CMOS RAM if the Initialize CMOS RAM in every boot AMIBIOS POST option was set in AMIBCP or the <End> key was pressed.

- 12 Next, disabling DMA controllers 1 and 2 and interrupt controllers 1 and 2.

- 13 The video display has been disabled. Port B has been initialized. Next, initializing the chipset.

- 14 The 8254 timer test will begin next.

- 19 The 8254 timer test is over. Starting the memory refresh test next.

- 1A The memory refresh test line is toggling. Checking the 15 second on/off time next.

- 23 Reading the 8042 input port and disabling the MEGAKEY Green PC feature next. Making the BIOS code segment writable and performing any necessary configuration before initializing the interrupt vectors.

- 24 The configuration required before interrupt vector initialization has completed. Interrupt vector initialization is done. Clearing the password if the POST DIAG switch is on.

- 25 Interrupt vector initialization is done. Clearing the password if the POST DIAG Switch is on.

- 27 Any initialization before setting video mode will be done next.

Check

PointDescription

- 28 Initialization before setting the video mode is complete. Configuring the monochrome mode and color mode settings next.
- 2A Bus initialization system, static, output devices will be done next, if present.
- 2B Passing control to the video ROM to perform any required configuration before the video ROM test.
- 2C All necessary processing before passing control to the video ROM is done. Looking for the video ROM next and passing control to it.
- 2D The video ROM has returned control to BIOS POST. Performing any required processing after the video ROM had control.
- 2E Completed post-video ROM test processing. If the EGA/VGA controller is not found, performing the display memory read/write test next.
- 2F The EGA/VGA controller was not found. The display memory read/write test is about to begin.
- 30 The display memory read/write test passed. Look for retrace checking next.
- 31 The display memory read/write test or retrace checking failed. Performing the alternate display memory read/write test next.
- 32 The alternate display memory read/write test passed. Looking for alternate display retrace checking next.
- 34 Video display checking is over. Setting the display mode next.
- 37 The display mode is set. Displaying the power on message next.

Check

PointDescription

- 38 Initializing the bus input, IPL, and general devices next, if present.
- 39 Displaying bus initialization error messages.
- 3A The new cursor position has been read and saved. Displaying the Hit message next.
- 40 Preparing the descriptor tables next.
- 42 The descriptor tables are prepared. Entering protected mode for the memory test next.
- 43 Entered protected mode. Enabling interrupts for diagnostics mode next.
- 44 Interrupts enabled if the diagnostics switch is on. Initializing data to check memory wraparound at 0:0 next.
- 45 Data initialized. Checking for memory wraparound at 0:0 and finding the total system memory size next.
- 46 The memory wraparound test has completed. The memory size calculation has been completed. Writing patterns to test memory next.
- 47 The memory pattern has been written to extended memory. Writing patterns to the base 640 KB memory next.
- 48 Patterns written in base memory. Determining the amount of memory below 1 MB next.
- 49 The amount of memory below 1 MB has been found and verified. Determining the amount of memory above 1 MB memory next.
- 4B The amount of memory above 1 MB has been found and verified. Checking for a soft reset and clearing the memory below 1 MB for the soft reset next. If this is a power on situation, going to checkpoint 4Eh next.

Check

PointDescription

- 4C The memory below 1 MB has been cleared via a soft reset. Clearing the memory above 1 MB next.
- 4D The memory above 1 MB has been cleared via a soft reset. Saving the memory size next. Going to checkpoint 52h next.
- 4E The memory test started, but not as the result of a soft reset. Displaying the first 64 KB memory size next.
- 4F The memory size display has started. The display is updated during the memory test. Performing the sequential and random memory test next.
- 50 The memory below 1 MB has been tested and initialized. Adjusting the displayed memory size for relocation and shadowing next.
- 51 The memory size display was adjusted for relocation and shadowing. Testing the memory above 1 MB next.
- 52 The memory above 1 MB has been tested and initialized. Saving the memory size information next.
- 53 The memory size information and the CPU registers are saved. Entering real mode next.
- 54 Shutdown was successful. The CPU is in real mode. Disabling the Gate A20 line, parity, and the NMI next.
- 57 The A20 address line, parity, and the NMI are disabled. Adjusting the memory size depending on relocation and shadowing next.
- 58 The memory size was adjusted for relocation and shadowing. Clearing the Hit message next.
- 59 The Hit message is cleared. The <WAIT> message is displayed. Starting the DMA and interrupt controller test next.

Check

PointDescription

- | | |
|----|---|
| 60 | The DMA page register test passed. Performing the DMA Controller 1 base register test next. |
| 62 | The DMA controller 1 base register test passed. Performing the DMA controller 2 base register test next. |
| 65 | The DMA controller 2 base register test passed. Programming DMA controllers 1 and 2 next. |
| 66 | Completed programming DMA controllers 1 and 2. Initializing the 8259 interrupt controller next. |
| 7F | Extended NMI source enabling is in progress. |
| 80 | The keyboard test has started. Clearing the output buffer and checking for stuck keys. Issuing the keyboard reset command next. |
| 81 | A keyboard reset error or stuck key was found. Issuing the keyboard controller interface test command next. |
| 82 | The keyboard controller interface test completed. Writing the command byte and initializing the circular buffer next. |
| 83 | The command byte was written and global data initialization has been completed. Checking for a locked key next. |
| 84 | Locked key checking is over. Checking for a memory size mismatch with CMOS RAM data next. |
| 85 | The memory size check is done. Displaying a soft error and checking for a password or bypassing WINBIOS Setup next. |
| 86 | The password was checked. Performing any required programming before WINBIOS Setup next. |

Check

PointDescription

- 87 The programming before WINBIOS Setup has been completed. Uncompressing the WINBIOS Setup code and executing the AMIBIOS Setup or WINBIOS Setup utility next.
- 88 Returned from WINBIOS Setup and cleared the screen. Performing any necessary programming after WINBIOS Setup next.
- 89 The programming after WINBIOS Setup has been completed. Displaying the power-on screen message next.
- 8B The first screen message has been displayed. The <WAIT...> message is displayed. Performing the PS/2 mouse check and extended BIOS data area allocation check next.
- 8C Programming the WINBIOS Setup options next.
- 8D The WINBIOS Setup options are programmed. Resetting the hard disk controller next.
- 8F The hard disk controller has been reset. Configuring the floppy drive controller next.
- 91 The floppy drive controller has been configured. Configuring the hard disk drive controller next.
- 95 Initializing the bus option ROMs from C800 next.
- 96 Initializing before passing control to the adaptor ROM at C800.
- 97 Initialization before the C800 adaptor ROM gains control has been completed. The adaptor ROM check is next.
- 98 The adaptor ROM had control and has now returned control to BIOS POST. Performing any required processing after the option ROM returned control.

Check

PointDescription

- 99 Any initialization required after the option ROM test has been completed. Configuring the timer data area and printer base address next.
- 9A Set the timer and printer base addresses. Setting the RS-232 base address next.
- 9B Returned after setting the RS-232 base address. Performing any required initialization before the Coprocessor test next.
- 9C Required initialization before the Coprocessor test is over. Initializing the Coprocessor next.
- 9D Coprocessor initialized. Performing any required initialization after the Coprocessor test next.
- 9E Initialization after the Coprocessor test is complete. Checking the extended keyboard, keyboard ID, and Num Lock key next. Issuing the keyboard ID command next.
- A2 Displaying any soft errors next.
- A3 The soft error display has completed. Setting the keyboard typematic rate next.
- A4 The keyboard typematic rate is set. Programming the memory wait states next.
- A5 Memory wait state programming is over. Clearing the screen and enabling parity and the NMI next.
- A7 NMI and parity enabled. Performing any initialization required before passing control to the adaptor ROM at E000 next.
- A8 Initialization before passing control to the adaptor ROM at E000h completed. Passing control to the adaptor ROM at E000h next.

Check

PointDescription

| | |
|-----|--|
| A9 | Returned from adaptor ROM at E000h control. Next, performing any initialization required after the E000 option ROM had control. |
| AA | Initialization after E000 option ROM control has completed. Displaying the system configuration next. |
| AB | Building the multiprocessor table, if necessary. POST next. |
| B0 | The system configuration is displayed. |
| AC | Uncompressing the DMI data and initializing DMI. |
| B1 | Copying any code to specific areas. |
| D0h | The NMI is disabled. Power on delay is starting. Next, the initialization code checksum will be verified. |
| D1h | Initializing the DMA controller. Performing the keyboard controller BAT test. Starting memory refresh, and entering 4 GB flat mode next. |
| D3h | Starting memory sizing next. |
| D4h | Returning to real mode. Executing any OEM patches and setting the stack next. |
| D5h | Passing control to the uncompressed code in shadow RAM at E000:0000h. The initialization code is copied to segment 0 and control will be transferred to segment 0. |
| D6h | Control is in segment 0. Next, checking if <Ctrl><Home>was pressed and verifying the system BIOS checksum. |

If either <Ctrl><Home> was pressed or the system BIOS checksum is bad, the system will next go to checkpoint code E0h.

Otherwise, going to checkpoint code D7h.