



WEEE DISASSEMBLY INSTRUCTIONS

SUPERMICRO SYS-221H-TNR ENCLOSURE

Abstract

This document provides clear guidance for end-of-life recyclers on how to identify and disassemble reportable materials in compliance with the Waste Electrical and Electronic Equipment (WEEE) directive.

Table of Contents

1. Product Views.....	1
2. Reportable Materials on SYS-221H-TN24R.....	3
3. Disassemble Instructions	4
3.3 Step-by-Step Disassembly Instructions	6
1. Removing Cable and Chassis Top Cover.....	6
2. Removing Hard Disk Drive (HDD) / Solid State Drive (SDD)	7
3. Removing Power Supply	9
4. Removing Advanced I/O (AIOM) Network Card and TPM Card	10
5. Removing AIOM Cable	11
6. Removing Add-on Module (AOM)	12
7. Removing Fan	12
8. Removing Backplane	13
9. Removing Riser Bracket and Riser Card.....	13
10. Removing Processor	14
11. Removing DIMM	16
12. Removing the M.2 from the Motherboard	16
13. Removing the Power Supply Shroud	17
14. Removing Motherboard.....	18
15. Removing Control Panel.....	18

1. Product Views

Front view



Rear view



Product construct view

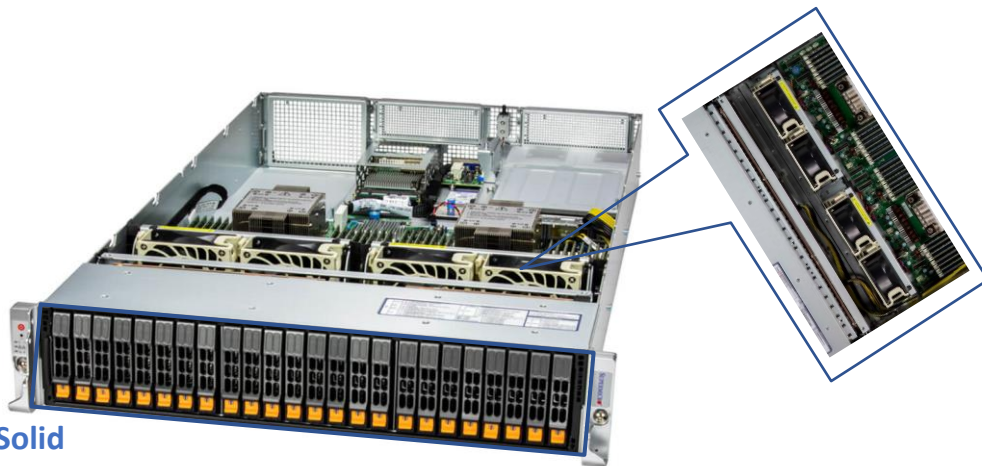

Hard Disk Drive/ Solid State Drive

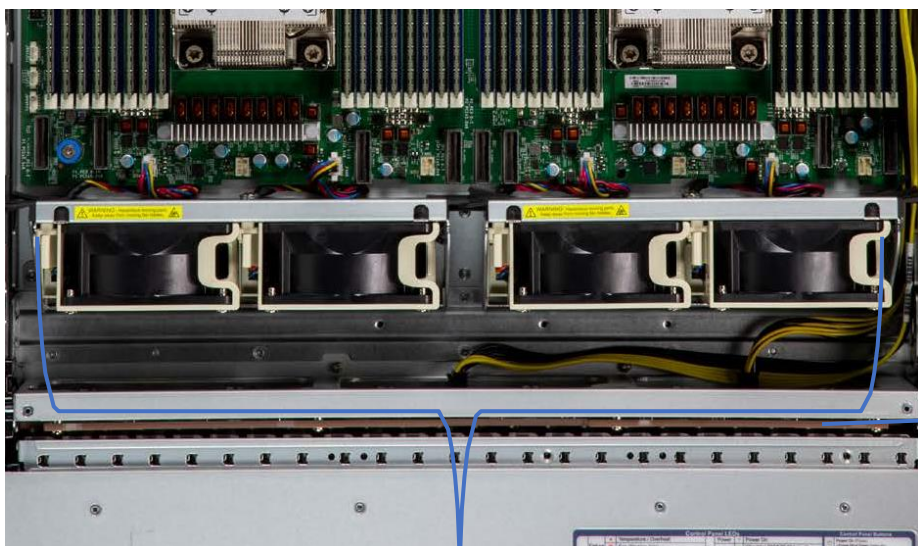

Backplane

Fans



Power Supply

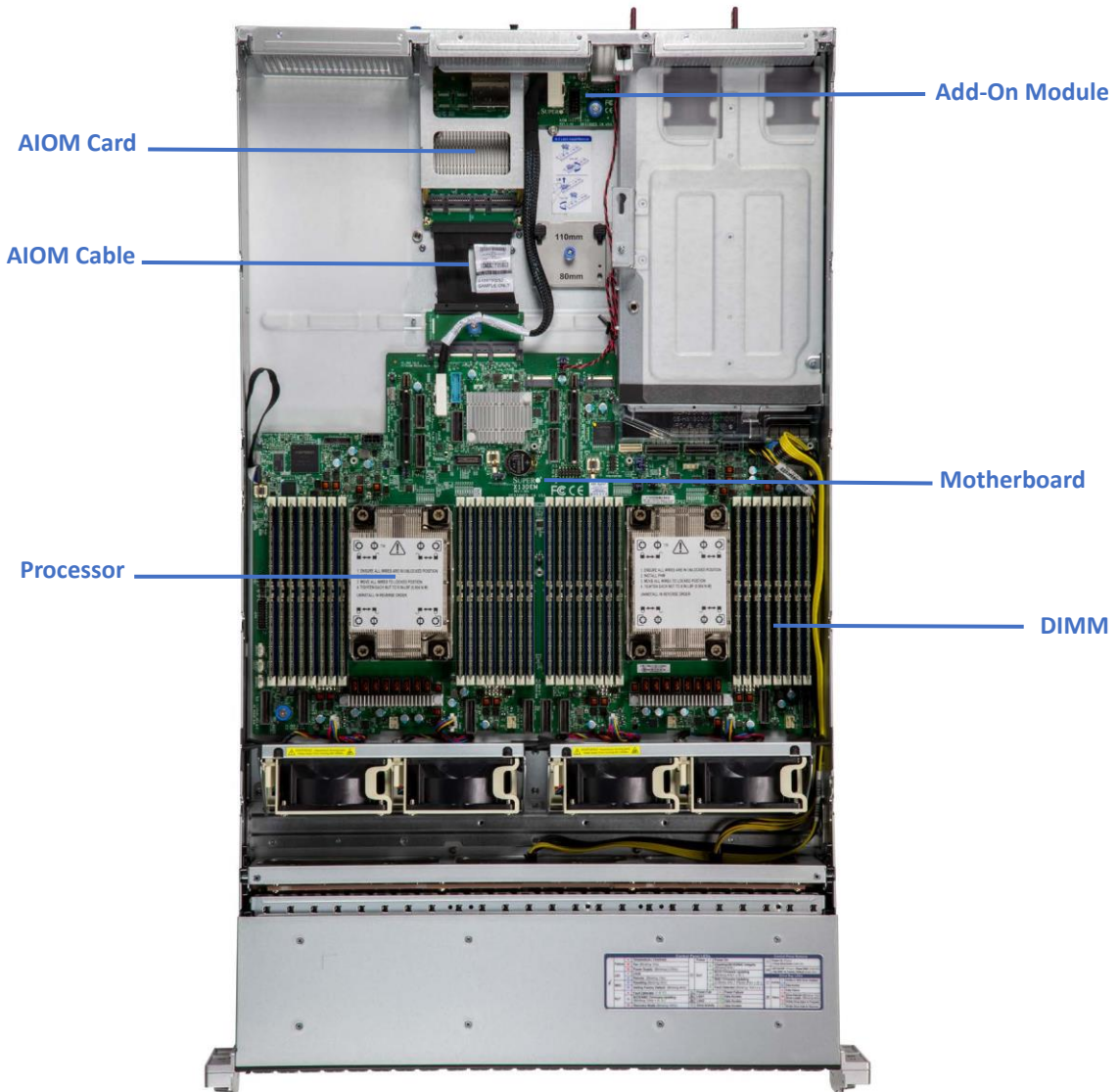

2. Reportable Materials on SYS-221H-TN24R

According to Article 8(2) and Annex VII of WEEE directive 2012/19/EU, Below materials and components should be selectively treated.

Description	Notes	No.	Quantity
Printed Circuit Boards (PCB) or Printed Circuit Assemblies (PCA)	With a surface greater than 10 sq cm	2.3, 3.5, 3.6, 4.2,4.3, 5.1, 6.1, 8.1, 9.1, 10.2, 11.1, 12.1, 14.1	21
Batteries	All types, including standard alkaline and lithium coin or button style batteries	14.2	1
Mercury-containing components	For example, mercury in lamps, display backlights, scanner lamps, switches, batteries		
Liquid Crystal Displays (LCD) with a surface greater than 100 sq cm	Includes background illuminated displays with gas discharge lamps		
Cathode Ray Tubes (CRT)			
Capacitors / condensers (Containing PCB/PCT)			
Electrolytic Capacitors / Condensers measuring greater than 2.5 cm in diameter or height	Depending on the power supply model	3.6	2
External electrical cables and cords		1.1	2
Gas Discharge Lamps			
Plastics containing Brominated Flame Retardants		15.1, 15.2	4
Components and parts containing toner and ink, including liquids, semi-liquids (gel/paste), and toner	Include the cartridges, print heads, tubes, vent chambers, and service stations.		
Components and waste containing asbestos			
Components, parts, and materials containing refractory ceramic fibers			
Components, parts, and materials containing radioactive substances			



3. Disassemble Instructions

The intent of this document is to provide guidance to recyclers on the presence of materials and components at the product / family level, as required by the EU WEEE Directive 2012/10/EU. This document should also help direct recyclers to proper methods for removing parts and general product disassembly instructions.

This chapter consists of three subsections:

Recommended disassembly tools, disassembled flowchart, and step-by-step disassembly instructions to direct recycler proper methods to treat.





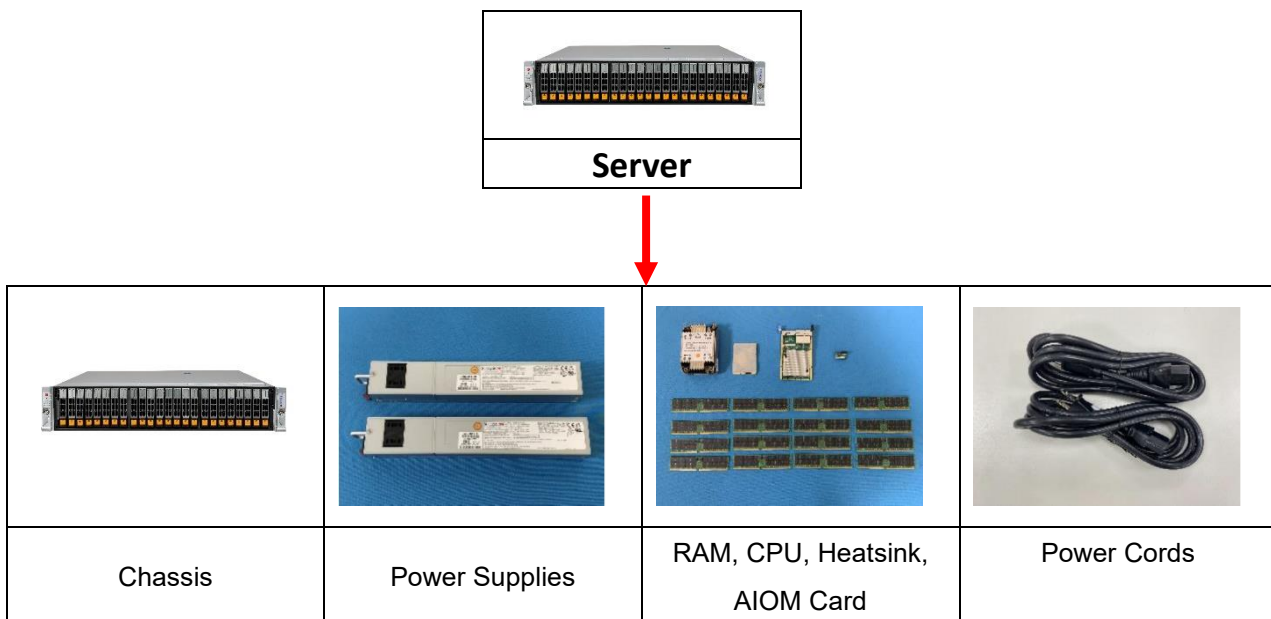

3.1 Recommended Disassembly Tools

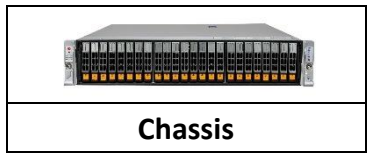
Disassembly tool	T30-bit screwdriver	
	Cross screwdriver	
	Flathead screwdriver	

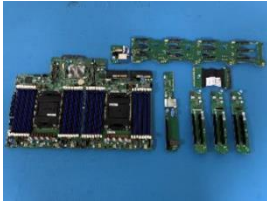

3.2 Disassembled flowchart









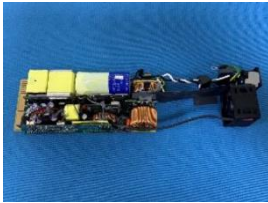

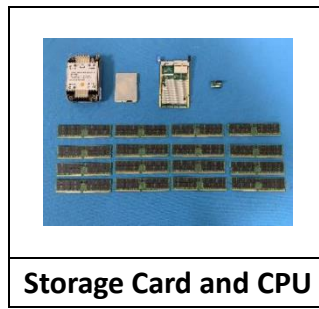
			
Backplane	Fans	Screws	Motherboard, Riser Cards, Backplane, Add- On Module, AIOM Cable
			
Battery	Cables	Power Supply Air Shroud	



		
Power Enclosure*2	Screws and Standoff*2 Set	Power Supply Module*2

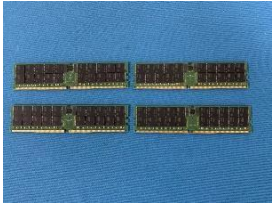

		
Heat Sink	Processor	SSD *2set
		
Add-On Module	DIMM *4Set	Power Cable

3.3 Step-by-Step Disassembly Instructions

1. Removing Cable and Chassis Top Cover

1. Use the operating system to power down the system.
2. After the system has completely shut-down, disconnect the power cords from the power supply modules.
3. Remove all cables/ unit from the server IO port.

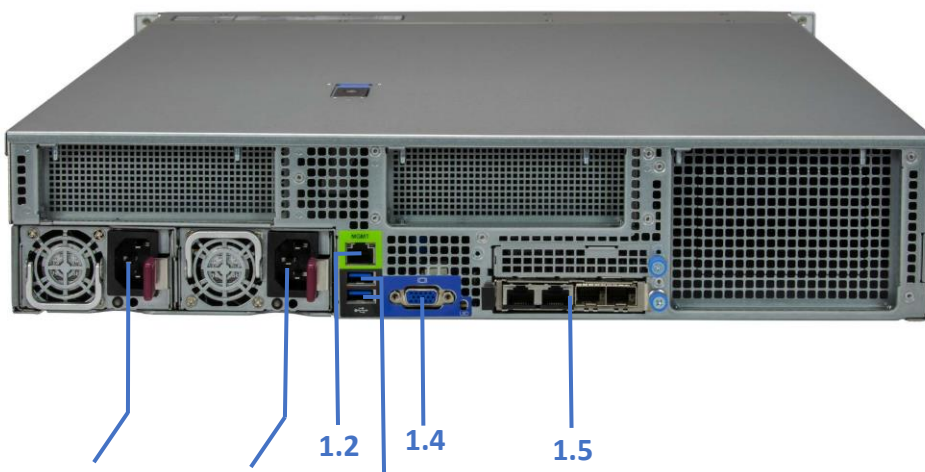

1.1 1.1 1.3
 4. The chassis top cover can be lifted off after pressing down on the release button and lifting the cover off.

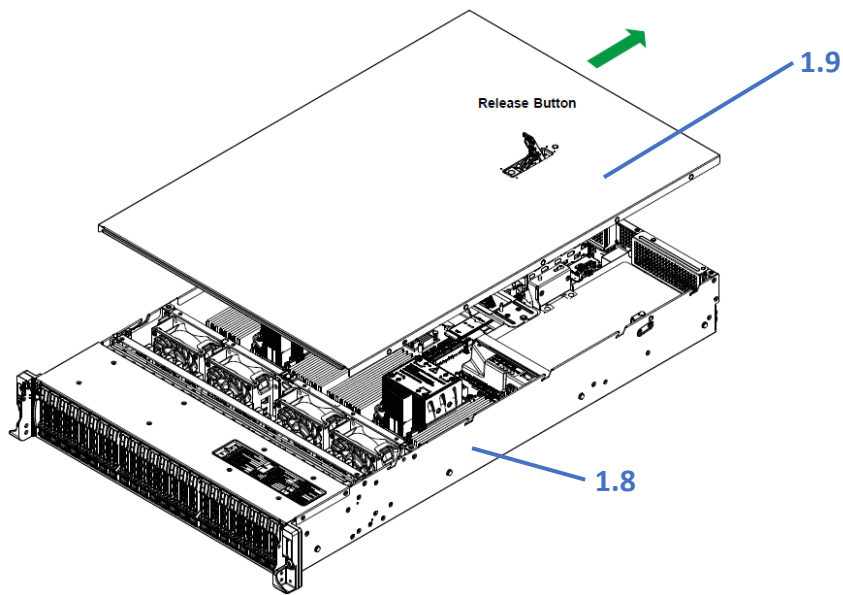

No.	Description	No.	Description
1.1	Power Cable	1.8	Chassis
1.2	BMC LAN Port	1.9	Top Cover
1.3	USB 2.0 Ports		
1.4	VGA Port		
1.5	AIOM/OCP NIC 3.0 Slot		

2. Removing Hard Disk Drive (HDD) / Solid State Drive (SDD)

1. Press the release button to extend the drive carrier handle.
2. Use the drive carrier handle to pull the drive out of the chassis.

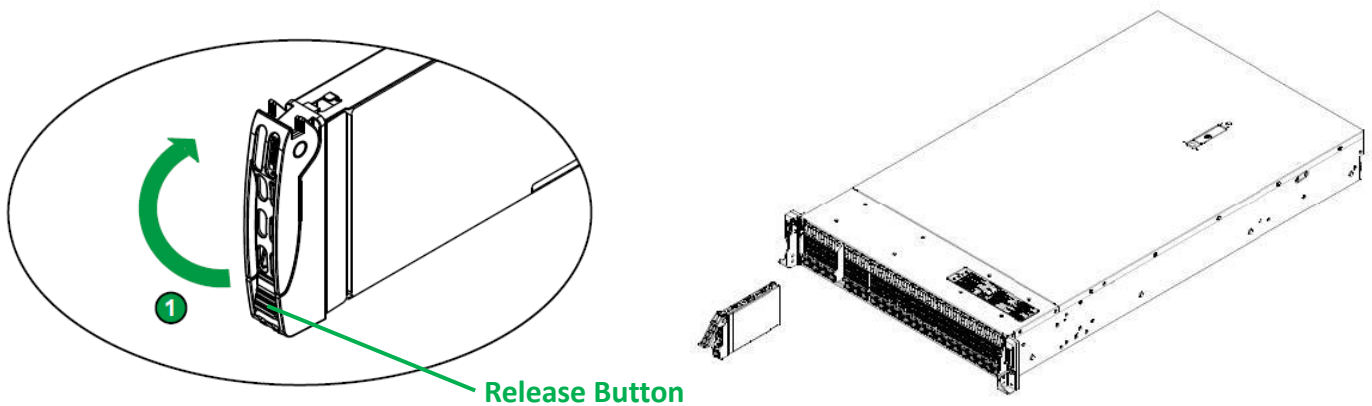

3. Pull and release the locking clasps holding the SSD in place with either a screwdriver flathead or by hand and lift the SSD out from the posts as shown below:

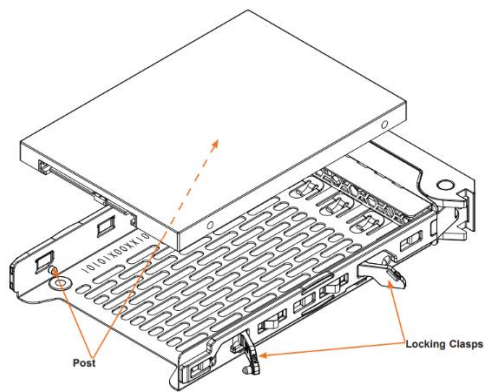

2.1



2.2

5. Use a cross screwdriver to remove drive enclosure

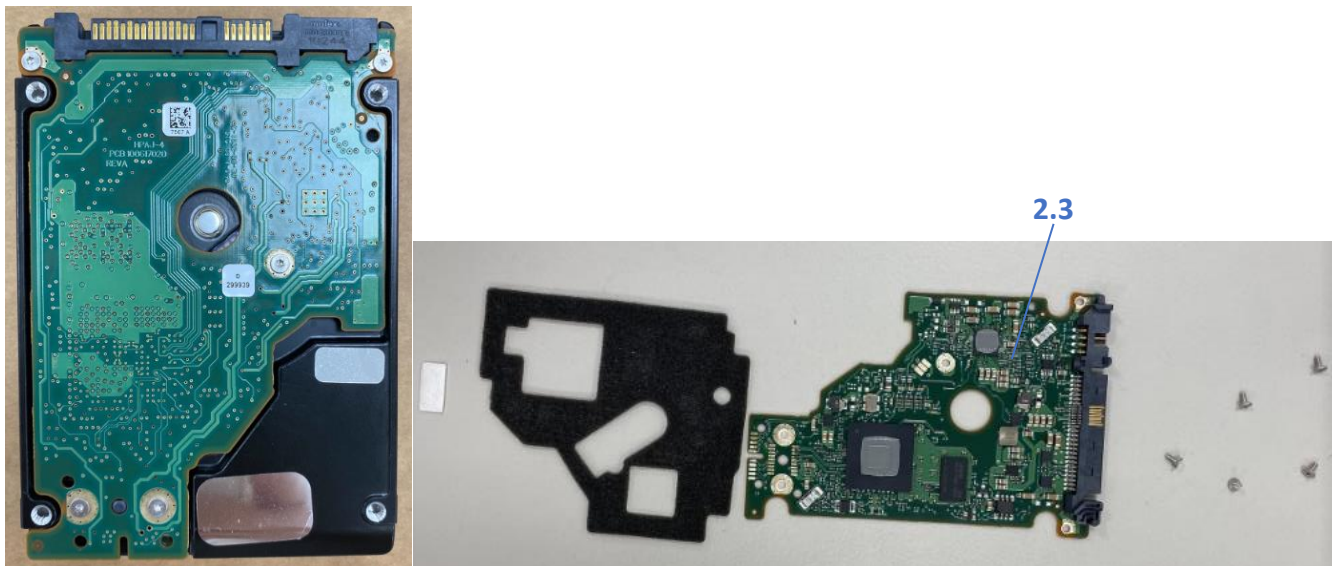

6. Use a cross screwdriver to remove screws and lift off the PCB

No.	Description
2.1	HDD/ SSD
2.2	Enclosure
2.3	PCB

3. Removing Power Supply

1. Press the release tab on the power supply.
2. Use the handle to gently slide the power supply out the back of the chassis.

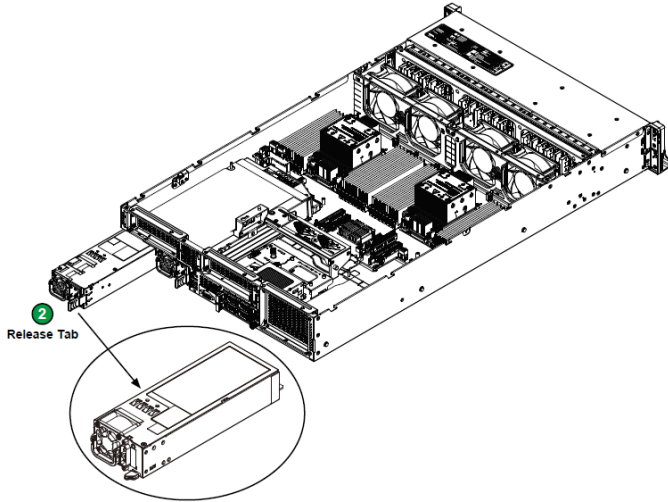

3.2

3. Remove the screw from the enclosure



3.3

3.4

4. Cut the power leads connected to the fan and lift the main board from the chassis

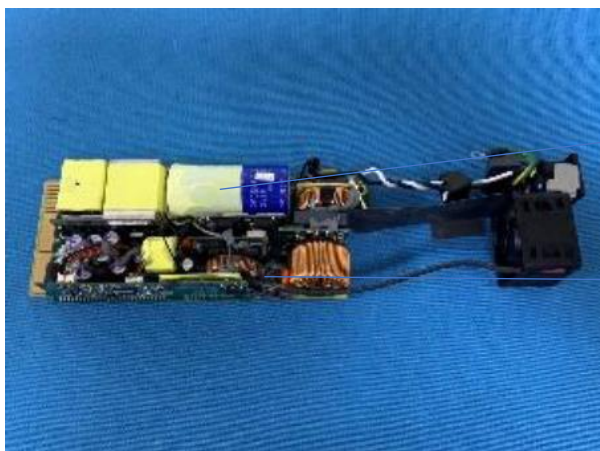

3.6

3.5

5. Use a flathead screwdriver to cut the capacitor adhesive and pin solder.



No.	Description
3.1	Power Supply
3.2	Power Enclosure
3.3	Fan
3.4	Fan Cable
3.5	Power Module PCB
3.6	Capacitor

4. Removing Advanced I/O (AIOM) Network Card and TPM Card

1. Loosen the thumbscrew using your hand.
2. Slide the AIOM out of the opening.
3. Press the pin and remove the pin and take the PCB from AIOM

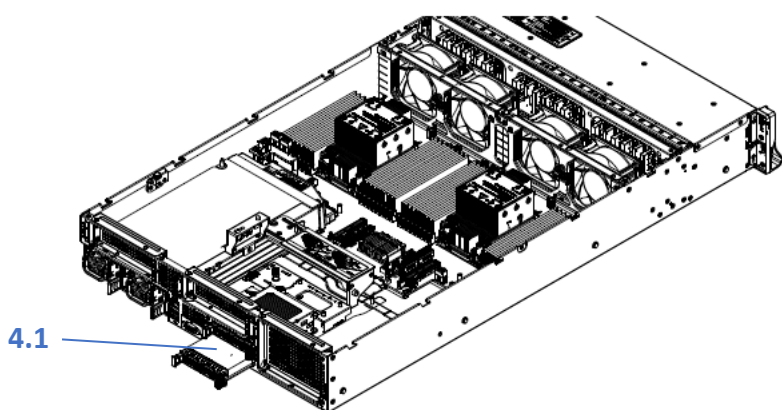

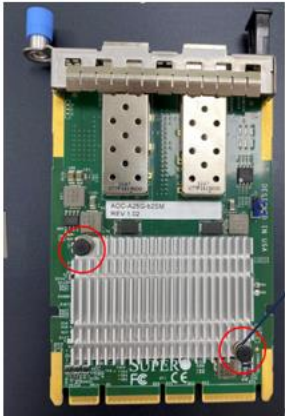

Press the pin

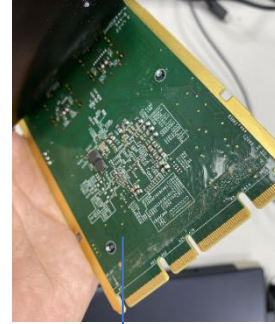

4.2

3. Find the motherboard JTPM1 connector and pull up the TPM

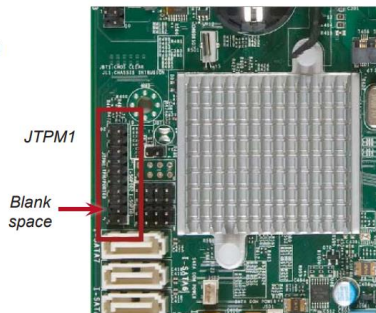
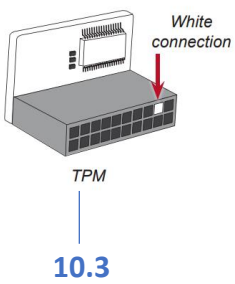

No.	Description
4.1	AIOM Network Card
4.2	AIOM Network Card PCB
4.2	TPM

5. Removing AIOM Cable

1. Unscrew the two screws (circled in red) using a screwdriver and loosen the thumb screw by hand.
2. Remove the cable from the motherboard.

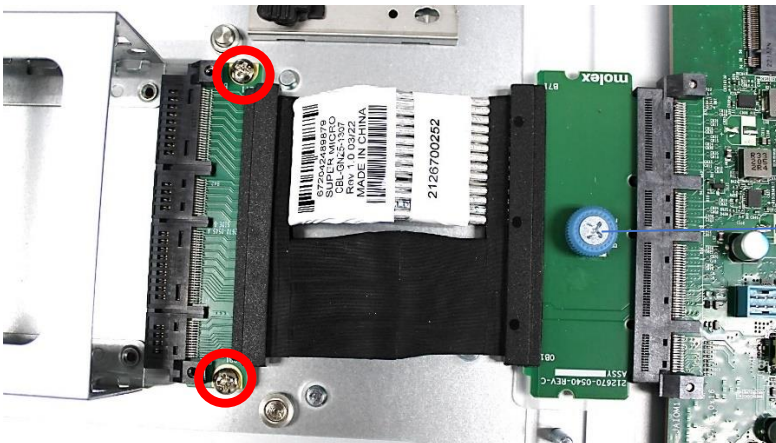

Thumb Screw

No.	Description
-----	-------------

6. Removing Add-on Module (AOM)

1. Loosen the thumbscrew and press down on the push pin.
2. Slide the AOM towards the push pin and then lift the AOM out of the system.

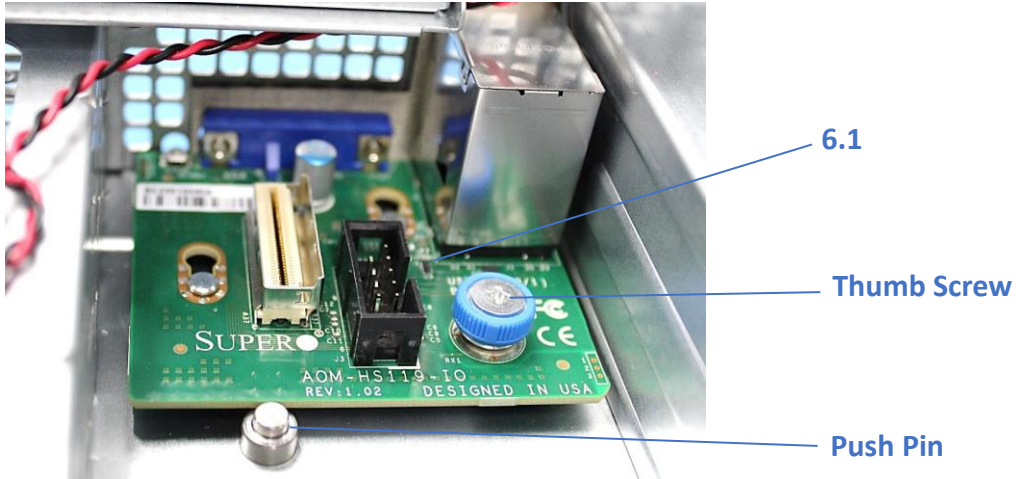

No.	Description
6.1	Add-on Module

7. Removing Fan

1. Disconnect the chassis fan from the motherboard fan connectors as shown below.

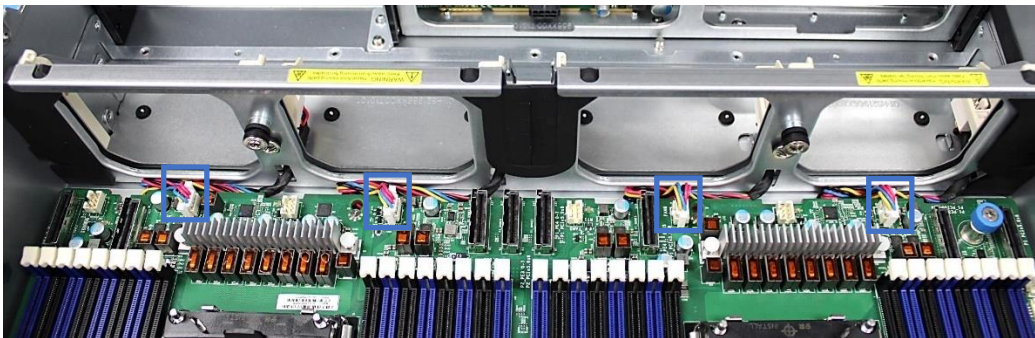

- Squeeze the fan tab as circled in red and lift the fan housing up and out of the chassis for each fan.

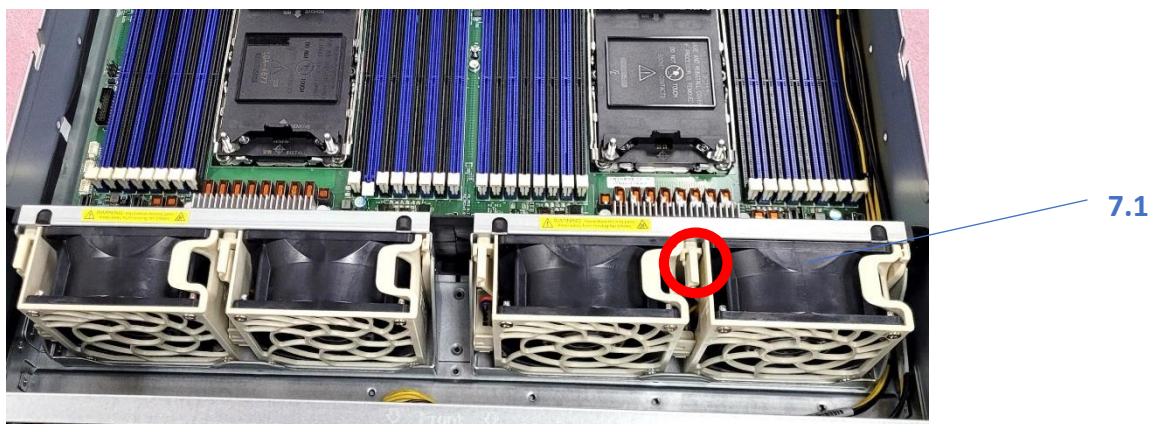

No.	Description
7.1	Cooling Fans

8. Removing Backplane

- Ensure all cables are disconnected from the backplane and then lift the backplane from the chassis.
- Unscrew the 4 screws as shown below to remove the backplane from the backplane bracket.

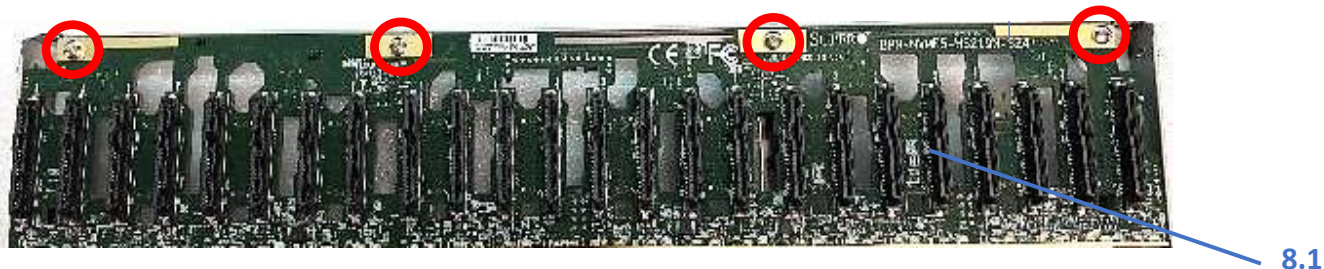

No.	Description
8.1	Backplane

9. Removing Riser Bracket and Riser Card

- Disconnect any cables connecting the riser cards to the system.
- Press the blue tab on the riser card and lift the riser card bracket away from the chassis

4. Unscrew the thumb screw holding the riser card and remove the riser card from bracket.

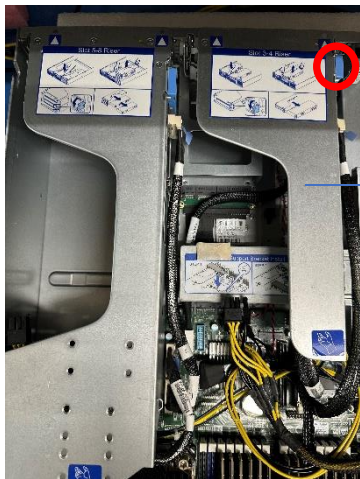

9.1

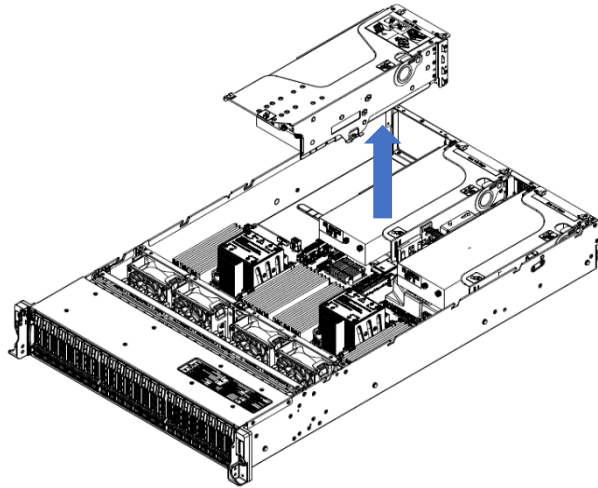

Thumb Screw

9.2

No.	Description
9.1	Riser Card Bracket
9.2	Riser Cards

10. Removing Processor

1. Removing the PHM (Processor Heatsink Module) from the motherboard, first shut down the system and unplug the AC power cord from all power supplies
2. Use a T30-bit screwdriver to loosen the four peek nuts on the heatsink in the sequence of A, B, C, and D

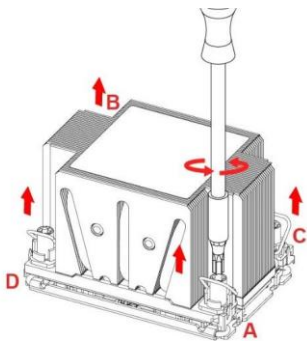

3. Once the peek nuts have been loosened from the CPU socket, press the rotating wires inward to unlatch the PHM from the socket, as shown below

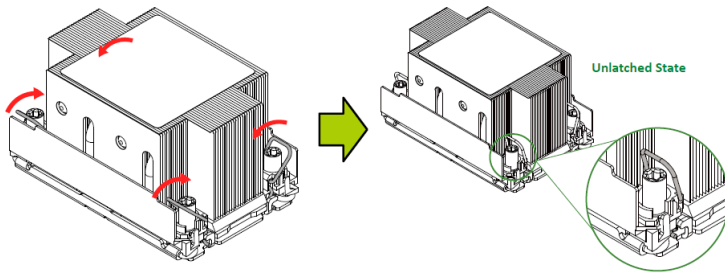

4. Gently lift the PHM upward to remove it from the CPU socket

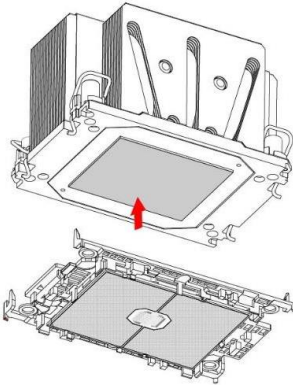

5. Use your hand to detach the four plastic clips (marked a, b, c, d) on the processor carrier assembly from the four corners of the heatsink (marked A, B, C, D), as shown below

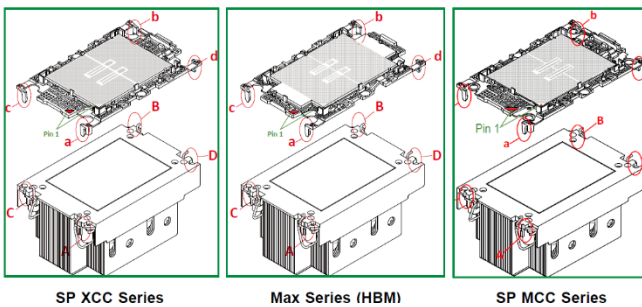

6. When all plastic clips have been detached from the heatsink, remove the processor carrier assembly from the heatsink

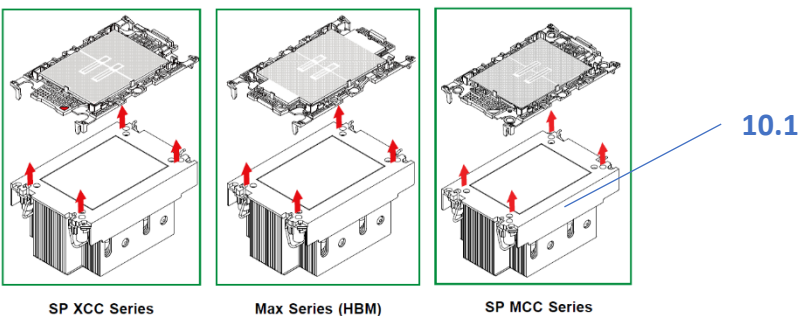

7. Unlock the lever from its locked position and push it upwards to disengage the processor from the processor carrier, as shown below right

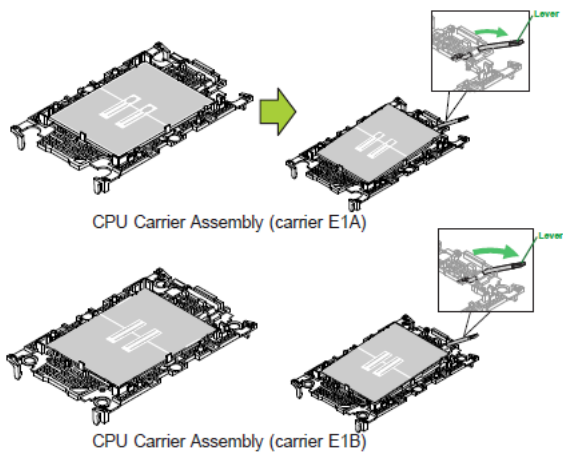

8. Once the processor has been loosened from the carrier, carefully remove the processor from the carrier

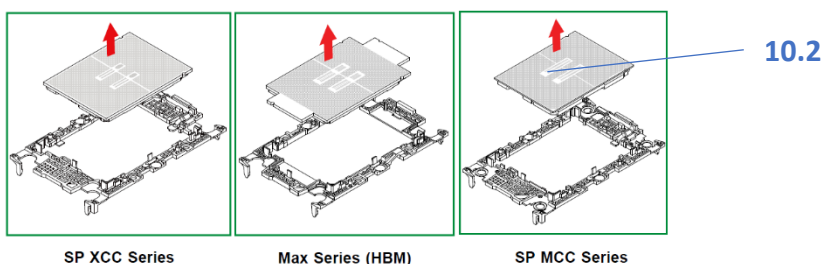

Note: Please handle the processor with care to avoid damaging it or its pins

No.	Description
10.1	Heat Sink
10.2	Processor

11. Removing DIMM

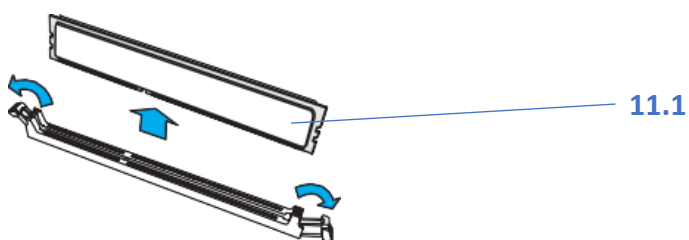

1. Hand press both release tabs on the ends of the DIMM module to unlock it
2. Once the DIMM module is loose, remove it from the memory slot

No.	Description
11.1	DIMM

12. Removing the M.2 from the Motherboard

1. Locate the M.2 on the motherboard and press down on the clip holding the M.2 in place.
2. Gently pull the M.2 out of the socket.

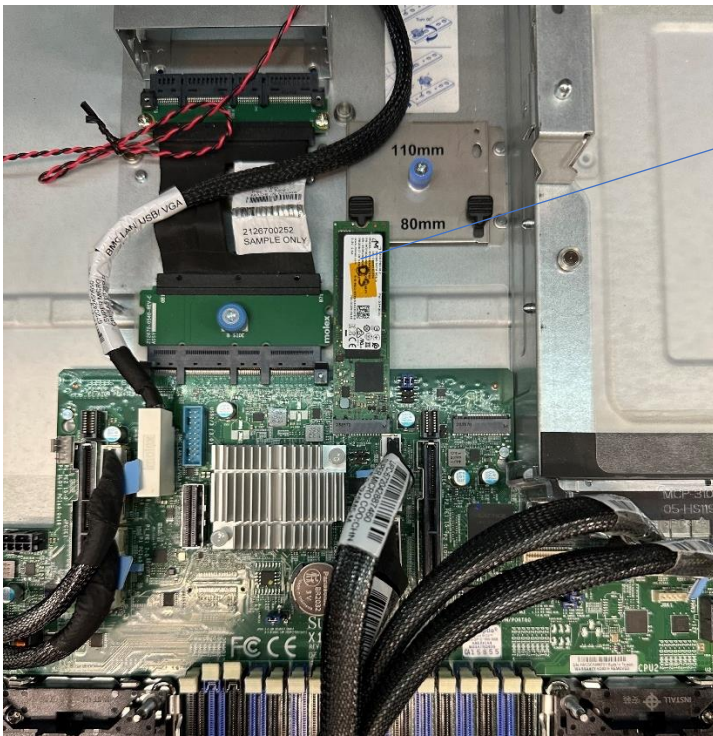

12.1

No.	Description
12.1	M.2

13. Removing the Power Supply Shroud

1. Locate the Power Supply Shroud on the motherboard and lift it out of the system.



13.1

No.	Description
13.1	Power Supply Shroud

14. Removing Motherboard

1. Loosen the two thumb screws on the motherboard and lift the motherboard out of the chassis.
2. Push aside the small clamp that covers the edge of the battery. When the battery is released, lift it out of the holder.

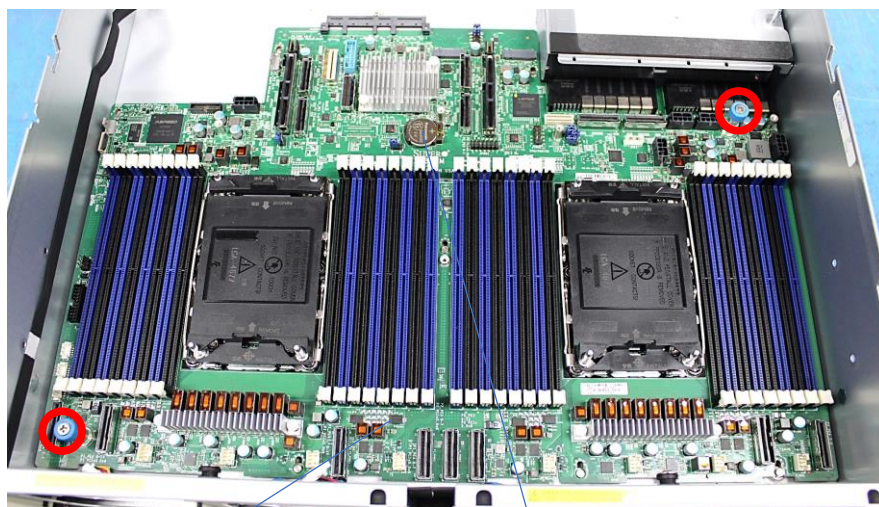

14.1

14.2

LITHIUM BATTERY

BATTERY HOLDER

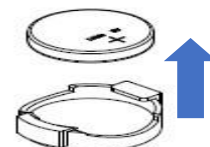

No.	Description
14.1	Motherboard
14.2	Battery

15. Removing Control Panel



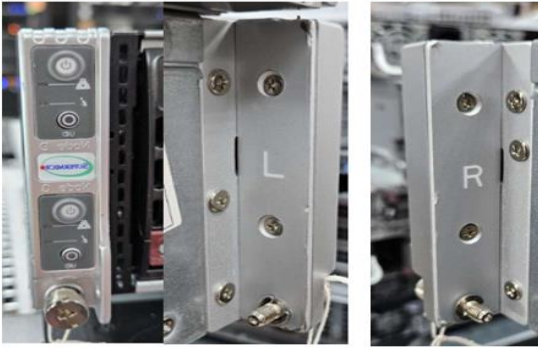

Remove control panel screw (R and L) from the chassis.



15.1

15.2

Remove bucket screw and hand screw (R and L) from control panel and used hand remove bucket mylar.

No.	Description
15.1	Control Panel Cover L & R
15.2	MYLAR_L & R

When the all the steps are complete, the chassis enclosure can be recycled.