



# AOC-M25G-m4S



## User's Guide

Revision 1.0a

---

The information in this User's Guide has been carefully reviewed and is believed to be accurate. The vendor assumes no responsibility for any inaccuracies that may be contained in this document, and makes no commitment to update or to keep current the information in this user's guide, or to notify any person or organization of the updates. **Please Note: For the most up-to-date version of this user's guide, please see our Website at [www.supermicro.com](http://www.supermicro.com).**

Super Micro Computer, Inc. ("Supermicro") reserves the right to make changes to the product described in this user's guide at any time and without notice. This product, including software and documentation, is the property of Supermicro and/or its licensors, and is supplied only under a license. Any use or reproduction of this product is not allowed, except as expressly permitted by the terms of said license.

IN NO EVENT WILL SUPER MICRO COMPUTER, INC. BE LIABLE FOR DIRECT, INDIRECT, SPECIAL, INCIDENTAL, SPECULATIVE OR CONSEQUENTIAL DAMAGES ARISING FROM THE USE OR INABILITY TO USE THIS PRODUCT OR DOCUMENTATION, EVEN IF ADVISED OF THE POSSIBILITY OF SUCH DAMAGES. IN PARTICULAR, SUPER MICRO COMPUTER, INC. SHALL NOT HAVE LIABILITY FOR ANY HARDWARE, SOFTWARE, OR DATA STORED OR USED WITH THE PRODUCT, INCLUDING THE COSTS OF REPAIRING, REPLACING, INTEGRATING, INSTALLING OR RECOVERING SUCH HARDWARE, SOFTWARE, OR DATA.

---

Any disputes arising between the manufacturer and the customer shall be governed by the laws of Santa Clara County in the State of California, USA. The State of California, County of Santa Clara shall be the exclusive venue for the resolution of any such disputes. Supermicro's total liability for all claims will not exceed the price paid for the hardware product.

---

FCC Statement: This equipment has been tested and found to comply with the limits for a Class A digital device pursuant to Part 15 of the FCC Rules. These limits are designed to provide reasonable protection against harmful interference when the equipment is operated in a commercial environment. This equipment generates, uses, and can radiate radio frequency energy and, if not installed and used in accordance with the manufacturer's instruction manual, may cause harmful interference with radio communications. Operation of this equipment in a residential area is likely to cause harmful interference, in which case you will be required to correct the interference at your own expense.

---

**California Best Management Practices Regulations for Perchlorate Materials:** This Perchlorate warning applies only to products containing CR (Manganese Dioxide) Lithium coin cells. "Perchlorate Material-special handling may apply. See [www.dtsc.ca.gov/hazardouswaste/perchlorate](http://www.dtsc.ca.gov/hazardouswaste/perchlorate)".

---



**WARNING:** This product can expose you to chemicals including lead, known to the State of California to cause cancer and birth defects or other reproductive harm. For more information, go to [www.P65Warnings.ca.gov](http://www.P65Warnings.ca.gov).

The products sold by Supermicro are not intended for and will not be used in life support systems, medical equipment, nuclear facilities or systems, aircraft, aircraft devices, aircraft/emergency communication devices or other critical systems whose failure to perform be reasonably expected to result in significant injury or loss of life or catastrophic property damage. Accordingly, Supermicro disclaims any and all liability, and should buyer use or sell such products for use in such ultra-hazardous applications, it does so entirely at its own risk. Furthermore, buyer agrees to fully indemnify, defend and hold Supermicro harmless for and against any and all claims, demands, actions, litigation, and proceedings of any kind arising out of or related to such ultra-hazardous use or sale.

---

User's Guide Revision 1.0a

Release Date: April 22, 2019

Unless you request and receive written permission from Super Micro Computer, Inc., you may not copy any part of this document.

Information in this document is subject to change without notice. Other products and companies referred to herein are trademarks or registered trademarks of their respective companies or mark holders.

Copyright © 2019 by Super Micro Computer, Inc.  
All rights reserved.

**Printed in the United States of America**

## Preface

### About this User's Guide

This user's guide is written for system integrators, PC technicians, and knowledgeable PC users. It provides information for the installation and use of the AOC-M25G-m4S add-on card.

### About this Add-on Card

The Supermicro® AOC-M25G-m4S is one of the most feature-rich 25GbE controllers in the market. With quad-port 25GbE SFP28 connectivity in the SIOM (Super I/O Module) form factor, it provides unparalleled density, performance, and functionality. Based on the Mellanox® ConnectX-4 Lx EN with features such as VXLAN, NVGRE, and RoCE, it provides flexible connectivity to meet different networking requirements. It is also compatible with 10GbE networks and provides cost-effective upgrade from 10GbE to 25GbE in data centers and cloud deployments.

### An Important Note to the User

All images and layouts shown in this user's guide are based upon the latest PCB revision available at the time of publishing. The card you have received may or may not look exactly the same as the graphics shown in this user's guide.

### Returning Merchandise for Service

A receipt or copy of your invoice marked with the date of purchase is required before any warranty service will be rendered. You can obtain service by calling your vendor for a Returned Merchandise Authorization (RMA) number. When returning the add-on-card to the manufacturer, the RMA number should be prominently displayed on the outside of the shipping carton, and the shipping package is mailed prepaid or hand-carried. Shipping and handling charges will be applied for all orders that must be mailed when service is complete. For faster service, You can also request a RMA authorization online (<http://www.supermicro.com>).

This warranty only covers normal consumer use and does not cover damages incurred in shipping or from failure due to the alternation, misuse, abuse or improper maintenance of products.

During the warranty period, contact your distributor first for any product problems.

## Conventions Used in the User's Guide

Pay special attention to the following symbols for proper system installation and to prevent damage to the system or injury to yourself:



**Note:** Additional information given to differentiate between various models or provides information for correct system setup.

## Naming Convention

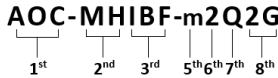

Character	Representation	Options
1st	Product Family	AOC: Add On Card
2nd	Form Factor	S: Standard, P: Proprietary, C: MicroLP, M: Super IO Module (SIOM), MH: SIOM Hybrid
3rd	Product Type/Speed	G: GbE (1Gb/s), TG: 10GbE (10Gb/s), 25G: 25GbE (25Gb/s), 40G: 40GbE (40Gb/s), 50G: 50GbE (50Gb/s), 100G: 100GbE (100Gb/s), IBE: EDR IB (100Gb/s), IBF: FDR IB (56Gb/s), IBQ: QDR IB (40Gb/s), HFI: Host Fabric Interface
4th	Chipset Model (Optional)	N: Niantec (82599), P: Powerville (i350), S: Sageville (X550), F: Fortville (XL710/X710), L: Lewisburg (PCH)
5th	Chipset Manufacturer	i: Intel, m: Mellanox, b: Broadcom
6th	Number of Ports	1: 1 port, 2: 2 ports, 4: 4 ports
7th	Connector Type (Optional)	S: SFP+/SFP28, T: 10GBase-T, Q: QSFP+, C: QSFP28
8th	2 <sup>nd</sup> Controller/Connector Type (Optional)	G: 1x GbE RJ45, 2G: GbE 2x RJ45, S: 1x 10G SFP+, T: 10GBase-T, 2T: 2x 10GBase-T

## SMC Networking Add-on Cards

Model	Type	Form Factor	Controller	Connection	Dimension (w/o Brackets) (L x H)	Power (W)
AOC-MGP-I2	GbE	SIOM	Intel® i350 AM2	2 RJ45 (1Gb/port)	3.622" (92mm) x 3.428" (87.08mm)	3.7
AOC-MGP-I4	GbE	SIOM	Intel® i350 AM4	4 RJ45 (1Gb/port)	3.622" (92mm) x 3.428" (87.08mm)	4.4
AOC-MTGN-I2S	10GbE	SIOM	Intel® 82599ES	2 SFP+ (10Gb/port)	3.622" (92mm) x 3.428" (87.08mm)	7.2
AOC-MTG-I4S	10GbE	SIOM	Intel® XL710-BM1	4 SFP+ (10Gb/port)	3.622" (92mm) x 3.428" (87.08mm)	7
AOC-MTG-I2T	10GbE	SIOM	Intel® X550-AT2	2 RJ45 (10GBase-T)	3.622" (92mm) x 3.428" (87.08mm)	13
AOC-MTG-I4T	10GbE	SIOM	2x Intel® X550-AT2	4 RJ45 (10GBase-T)	3.622" (92mm) x 3.428" (87.08mm)	26
AOC-MHBF-m1Q2G	FDR IB GbE	SIOM	Mellanox® ConnectX-3 Pro Intel® i350	1 QSFP (56Gb/port) 2 RJ45 (1Gb/port)	3.622" (92mm) x 3.428" (87.08mm)	9
AOC-MHBF-m2Q2G	FDR IB GbE	SIOM	Mellanox® ConnectX-3 Pro Intel® i350	2 QSFP (56Gb/port) 2 RJ45 (1Gb/port)	3.622" (92mm) x 3.428" (87.08mm)	11
AOC-MHBE-m1CG	EDR IB GbE	SIOM	Mellanox® ConnectX-4 VPI Intel® i210	1 QSFP28 (100Gb/port) 1 RJ45 (1Gb/port)	3.622" (92mm) x 3.428" (87.08mm)	19
AOC-MH25G-b2S2G	25GbE	SIOM	Broadcom® BCM57414 Intel® i350	2 SFP28 (25Gb/port) 2 RJ45 (1Gb/port)	3.622" (92mm) x 3.428" (87.08mm)	9
AOC-MH25G-m2S2T	25GbE	SIOM	Mellanox® ConnectX-4 Lx EN Intel® X550-AT2	2 SFP28 (25Gb/port) 2 RJ45 (10GBase-T)	3.622" (92mm) x 3.428" (87.08mm)	25
AOC-M25G-m4S	25GbE	SIOM	Mellanox® ConnectX-4 Lx EN	4 SFP28 (25Gb/port)	3.622" (92mm) x 3.428" (87.08mm)	20
AOC-M25G-I2S	25GbE	SIOM	Intel® XXV710	2 SFP28 (25Gb/port)	3.622" (92mm) x 3.428" (87.08mm)	11.8
AOC-MHFI-I1C	Omni-Path	SIOM	Intel® OP HFI ASIC (Wolf River WFR-B)	1 QSFP28 (100Gb/port)	3.622" (92mm) x 3.428" (87.08mm)	15

Model	Type	Form Factor	Interface	Controller	Connection	Dimension (w/o Brackets) (L x H)	Power (W)
AOC-SGP-i2	GbE	Standard LP	PCI-E x4	Intel® I350 AM2	2 RJ45 (1Gb/port)	3.9" (99mm) x 2.73" (69mm)	3.5
AOC-SGP-i4	GbE	Standard LP	PCI-E x4	Intel® I350 AM4	4 RJ45 (1Gb/port)	3.9" (99mm) x 2.73" (69mm)	5
AOC-STG-i2T	10GbE	Standard LP	PCI-E x8	Intel® X540-AT2	2 RJ45 (10GbBase-T)	5.9" (150mm) x 2.73" (69mm)	13
AOC-STGS-i1T	10GbE	Standard LP	PCI-E x4	Intel® X550-AT	1 RJ45 (10GbBase-T)	5.9" (150mm) x 2.73" (69mm)	9
AOC-STGS-i2T	10GbE	Standard LP	PCI-E x4	Intel® X550-AT2	2 RJ45 (10GbBase-T)	5.9" (150mm) x 2.73" (69mm)	11
AOC-STG-b2T	10GbE	Standard LP	PCI-E x8	Broadcom® BCM57416	2 RJ45 (10GbBase-T)	5.6" (142mm) x 2.73" (69mm)	13.1
AOC-STG-i4T	10GbE	Standard LP	PCI-E x8	Intel® XL710-BM1	4 RJ45 (10GbBase-T)	5.9" (149mm) x 2.73" (69mm)	15.5
AOC-STGN-i1S	10GbE	Standard LP	PCI-E x8	Intel® 82598EN	1 SFP+ (10Gb/port)	4.0" (102mm) x 2.73" (69mm)	10
AOC-STGN-i2S	10GbE	Standard LP	PCI-E x8	Intel® 82598ES	2 SFP+ (10Gb/port)	4.0" (102mm) x 2.73" (69mm)	11.2
AOC-STGF-i2S	10GbE	Standard LP	PCI-E x8	Intel® X710-BM2	2 SFP+ (10Gb/port)	5.19" (132mm) x 2.73" (69mm)	5.6
AOC-STG-b4S	10GbE	Standard LP	PCI-E x8	Broadcom® BCM57840S	4 SFP+ (10Gb/port)	5.4" (137mm) x 2.73" (69mm)	14
AOC-STG-i4S	10GbE	Standard LP	PCI-E x8	Intel® XL710-BM1	4 SFP+ (10Gb/port)	5.9" (150mm) x 2.73" (69mm)	8
AOC-S25G-m2S	25GbE	Standard LP	PCI-E x8	Mellanox® CX-4 LX	2 SFP28 (25Gb/port)	5.6" (142mm) x 2.713" (69mm)	8.7
AOC-S25G-b2S	25GbE	Standard LP	PCI-E x8	Broadcom® BCM57414	2 SFP28 (25Gb/port)	5.6" (142mm) x 2.713" (69mm)	5.2
AOC-S25G-i2S	25GbE	Standard LP	PCI-E x8	Intel® XXV710	2 SFP28 (25Gb/port)	6.1" (155mm) x 2.713" (69mm)	7.2
AOC-S40G-i1Q	40GbE	Standard LP	PCI-E x8	Intel® XL710-BM1	1 QSFP+ (40Gb/port)	5.9" (150mm) x 2.73" (69mm)	6.5
AOC-S40G-i2Q	40GbE	Standard LP	PCI-E x8	Intel® XL710-BM2	2 QSFP+ (40Gb/port)	5.9" (150mm) x 2.73" (69mm)	7
AOC-S100G-m2C	100GbE	Standard LP	PCI-E x16	Mellanox® CX-4 EN	2 QSFP28 (100Gb/port)	6.6" (168mm) x 2.73" (69mm)	16.3
AOC-PTG-i1S	10GbE	Proprietary	PCI-E x8	Intel® 82598EN	1 SFP+ (10Gb/port)	10.04" (255mm) x .78" (20mm)	7.5
AOC-UG-i4	GbE	UIO FH	PCI-E x8	Intel® 82571EB	4 RJ45 (1Gb/port)	6.6" (167mm) x 3.9" (98mm)	10
AOC-CGP-i2	GbE	MicroLP	PCI-E x4	Intel® I350 AM2	2 RJ45 (1Gb/port)	4.45" (113mm) x 1.54" (39mm)	4
AOC-CG-i2	GbE	MicroLP	PCI-E x4	Intel® 82580	2 RJ45 (1Gb/port)	4.45" (113mm) x 1.3" (34mm)	4
AOC-CTG-i1S	10GbE	MicroLP	PCI-E x8	Intel® 82598EN	1 SFP+ (10Gb/port)	4.85" (123mm) x 1.54" (39mm)	10
AOC-CTG-i2S	10GbE	MicroLP	PCI-E x8	Intel® 82598ES	2 SFP+ (10Gb/port)	4.85" (123mm) x 1.54" (39mm)	11
AOC-CTG-i2T	10GbE	MicroLP	PCI-E x8	Intel® X540-AT2	2 RJ45 (10GbBase-T)	4.8" (123mm) x 1.54" (39mm)	13
AOC-CTGS-i2T	10GbE	MicroLP	PCI-E x4	Intel® X550-AT2	2 RJ45 (10GbBase-T)	4.45" (113mm) x 1.54" (39mm)	12
AOC-C25G-m1S	25GbE	MicroLP	PCI-E x8	Mellanox® CX-4 Lx EN	1 SFP28 (25Gb/port)	4.45" (113mm) x 1.54" (39mm)	8.5

## Contacting Supermicro

### Headquarters

Address: Super Micro Computer, Inc.  
980 Rock Ave.  
San Jose, CA 95131 U.S.A.

Tel: +1 (408) 503-8000

Fax: +1 (408) 503-8008

Email: [marketing@supermicro.com](mailto:marketing@supermicro.com) (General Information)  
[support@supermicro.com](mailto:support@supermicro.com) (Technical Support)

Website: [www.supermicro.com](http://www.supermicro.com)

### Europe

Address: Super Micro Computer B.V.  
Het Sterrenbeeld 28, 5215 ML  
's-Hertogenbosch, The Netherlands

Tel: +31 (0) 73-6400390

Fax: +31 (0) 73-6416525

Email: [sales@supermicro.nl](mailto:sales@supermicro.nl) (General Information)  
[support@supermicro.nl](mailto:support@supermicro.nl) (Technical Support)  
[rma@supermicro.nl](mailto:rma@supermicro.nl) (Customer Support)

### Asia-Pacific

Address: Super Micro Computer, Inc.  
4F, No. 232-1, Liancheng Rd.  
Chung-Ho Dist., New Taipei City 235  
Taiwan, R.O.C.

Tel: +886-(2) 8226-3990

Fax: +886-(2) 8226-3991

Website: [www.supermicro.com.tw](http://www.supermicro.com.tw)

Email: [support@supermicro.com.tw](mailto:support@supermicro.com.tw) (Technical Support)

Tel: +886-(2) 8226-5990 (Technical Support)

---

---

## Table of Contents

### ***Preface***

#### ***Chapter 1 Overview***

1-1	Overview .....	1-1
1-2	Key Features .....	1-1
1-3	Specifications .....	1-1
1-4	Available SKUs .....	1-5
1-5	Similar Products .....	1-5
1-6	Optional Parts List.....	1-6

#### ***Chapter 2 Hardware Components***

2-1	Add-On Card Image and Layout.....	2-1
2-2	Major Components.....	2-2
2-3	SFP28 Ethernet Connections.....	2-2
2-4	System Management Bus (SMB).....	2-4

#### ***Chapter 3 Installation***

3-1	Static-Sensitive Devices.....	3-1
3-2	Before Installation .....	3-2
3-3	Installing the Add-on Card .....	3-2
3-4	Installing Drivers (for Mellanox® ConnectX®-4 Lx En) .....	3-5
3-5	Configuring EFI mode from System Setup .....	3-7

# Chapter 1

## Overview

### 1-1 Overview

Congratulations on purchasing your add-on card from an acknowledged leader in the industry. Supermicro products are designed with the utmost attention to detail to provide you with the highest standards in quality and performance. For product support and updates, please refer to our website at <http://www.supermicro.com/products/nfo/networking.cfm#adapter>.

### 1-2 Key Features

The key features of this add-on card include:

- Supermicro Super I/O Module (SIOM) form factor
- Mellanox® ConnectX-4 Lx EN 25GbE controller, Quad-port SFP28 connectors
- Hardware offloads for NVGRE, VXLAN, and GENEVE encapsulated traffic
- SR-IOV for virtualization
- Low latency RDMA over Converged Ethernet (RoCE)
- Jumbo frames support
- NC-SI for remote management
- Asset Management features with thermal sensor
- RoHS compliant 6/6 

### 1-3 Specifications

#### General

- Super I/O Module (SIOM) form factor
- Mellanox® ConnectX-4 Lx EN 25GbE controller
- Quad SFP28 connectors with speeds up to 25 Gbps per port



## **Ethernet**

- 25GbE/10GbE
- IEEE 802.3ad, 802.1AX Link Aggregation
- IEEE 802.1Q, 802.1P VLAN tags and priority
- IEEE 1588v2
- Jumbo frames support

## **Enhanced Features**

- Hardware-based reliable transport
- Collective operations offloads
- Vector collective operations offloads
- 64/66 encoding
- Dynamically Connected Transport (DCT)
- Enhanced atomic operations
- Support for MSI/MSI-X mechanisms

## **Storage Offloads**

- Stateless offloads for overlay networks and tunneling protocols
- Hardware offload of encapsulation of NVGRE and VXLAN overlay networks

## **Hardware-based I/O Virtualization**

- Single root IOV
- Multi-function per port
- Multiple queues per virtual machine
- VMware NetQueue support

## Virtualization

- SR-IOV: Up to 256 virtual functions
- SR-IOV: Up to 16 physical functions per port

## CPU Offloads

- RDMA over Converged Ethernet (RoCE)
- TCP/UDP/IP stateless offload
- LSO, LRO, checksum offload
- RSS (can be done on encapsulated packet), TSS, HDS, VLAN insertion/stripping, receive flow steering
- Intelligent interrupt coalescence

## Management Features

- Remote boot over iSCSI
- PXE and UEFI
- NC-SI for remote management

## OS Support

- RHEL/CentOS (7.2, 7.1, 7.0, 6.8, 6.7, 6.6, 6.5, 6.2)
- Windows (2012 R2, 2012)
- FreeBSD (11)
- VMware (6.5, 5.5)

## Cables Support

- SFP28: Direct attach copper cables
- SFP28: Fiber-optic cables (with required optional transceivers)

## Power Consumption

- Maximum 20W

## Operating Conditions

- Operating temperature: 0°C to 55°C (32°F to 131°F)
- Storage temperature: -40°C to 70°C (-40°F to 158°F)
- Storage humidity: 90% non-condensing relative humidity at 35°C

## Physical Dimensions

- Card PCB dimensions: 92mm (3.62in) x 87.1mm (3.43in) (W x D)

## Supported Platforms

- Supermicro® motherboards with Super I/O Module (SIOM) slot
- Supermicro® server systems with Super I/O Module slot (see SIOM Compatibility Matrix online at [http://www.supermicro.com/support/resources/AOC/AOC\\_Compatibility\\_SIOM.cfm](http://www.supermicro.com/support/resources/AOC/AOC_Compatibility_SIOM.cfm))



**Note:** This product is sold only as part of an integrated solution with Supermicro server systems.

## 1-4 Available SKUs

SKUs	Part Number	Description
AOC-M25G-m4S	BKT-0124L	4-port 25 Gigabit Ethernet Adapter with a swappable bracket for 2U+ chassis (Storage Servers)
AOC-M25G-m4SM	BKT-0120L	4-port 25 Gigabit Ethernet Adapter with an internal bracket for 1U chassis (Twin Servers)

## 1-5 Similar Products

Product Part Number	Form Factor	Protocols	Connector Type	Total Ports	Controller
AOC-MGP-i2	SIOM	1GbE	RJ45	2	Intel® i350
AOC-MGP-i4	SIOM	1GbE	RJ45	4	Intel® i350
AOC-MTGN-i2S	SIOM	10GbE	SFP+	2	Intel® 82599
AOC-MTG-i4S	SIOM	10GbE	SFP+	4	Intel® XL710
AOC-MTG-i2T	SIOM	10GbE	RJ45	2	Intel® X550
AOC-MTG-i4T	SIOM	10GbE	RJ45	4	Intel® X550
AOC-MH25G-m2S2T	SIOM	25GbE 1GbE	SFP28 RJ45	2 2	Mellanox® ConnectX-4Lx En Intel®X550
AOC-MHIBF-m2Q2G	SIOM	InfiniBand FDR GBE	QSFP+ RJ45	2 2	Mellanox® ConnectX-3 Pro Intel® i350
AOC-MHIBF-m1Q2G	SIOM	InfiniBand FDR GBE	QSFP+ RJ45	1 2	Mellanox® ConnectX-3 Pro Intel® i350
AOC-MHFI-i1C	SIOM	Omni-Path	QSFP28	1	Intel® OP HFI ASIC

## 1-6 Optional Parts List

	<b>Part Number</b>	<b>Description</b>
<b>SFP28 Copper Cable</b>	CBL-NTWK-0944-MS28C05M	0.5m 25GbE SFP28 to SFP28, Passive
<b>SFP28 Copper Cable</b>	CBL-NTWK-0944-MS28C10M	1m 25GbE SFP28 to SFP28, Passive
<b>SFP28 Copper Cable</b>	CBL-NTWK-0944-MS28C15M	1.5m 25GbE SFP28 to SFP28, Passive
<b>SFP28 Copper Cable</b>	CBL-NTWK-0944-MS28C20M	2m 25GbE SFP28 to SFP28, Passive
<b>SFP28 Copper Cable</b>	CBL-NTWK-0944-MS28C25M	2.5m 25GbE SFP28 to SFP28, Passive
<b>SFP28 Copper Cable</b>	CBL-NTWK-0944-MS28C30M	3m 25GbE SFP28 to SFP28, Passive
<b>SFP28 Transceiver Module</b>	AOM-SFP28-25GbE-SR-1-MLN	SFP28 Transceiver module 25 G, 850nm, MMF, LC

## Chapter 2

### Hardware Components

#### 2-1 Add-On Card Image and Layout

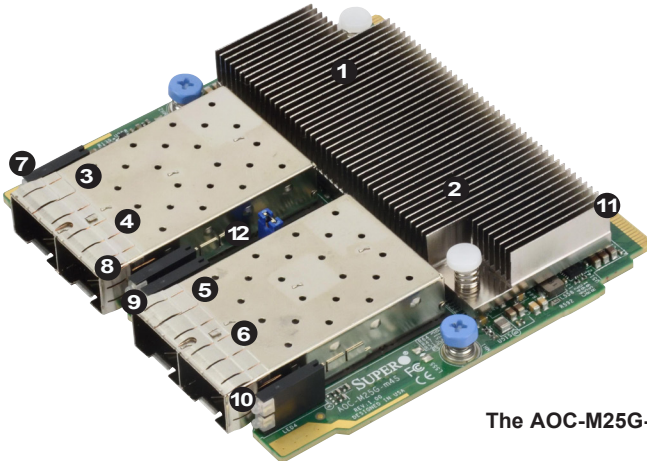

The AOC-M25G-m4S Image

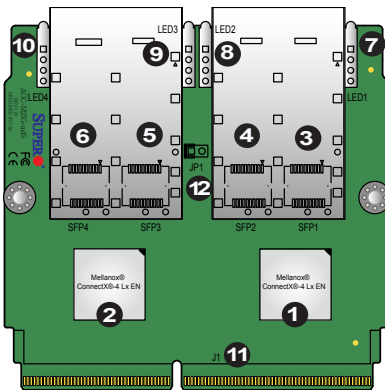

The AOC-M25G-m4S Layout

1. Mellanox® ConnectX®-4 Lx EN	7. LED1: SFP28 Port1 Link LED
2. Mellanox® ConnectX®-4 Lx EN	8. LED2: SFP28 Port2 Link LED
3. SFP28 Port1	9. LED3: SFP28 Port3 Link LED
4. SFP28 Port2	10. LED4: SFP28 Port4 Link LED
5. SFP28 Port3	11. J1: PCI-E 3.0 x16
6. SFP28 Port4	12. JP1: System Management Bus

## 2-2 Major Components

The following major components are installed on the AOC-M25G-m4S:

1. Two Mellanox® ConnectX®-4 Lx EN controllers
2. Four SFP28 (Small Form Factor Pluggable) ports
3. Four (4) SFP28 Link/Activity LED indicators
4. System Management Bus

## 2-3 SFP28 Ethernet Connections

### SFP28 (SFP1/SFP2/SFP3/SFP4) Connectors

Four small form-factor pluggable (SFP28) optical transceiver connectors (SFP1/SFP2/SFP3/SFP4) are located on the add-on card. These SFP28 ports provide Ethernet up to 25GbE network connections. See the layout on page 2-3 for the locations.

### SFP28 (SFP1/SFP2/SFP3/SFP4) Link/Activity LED Indicators

Four SFP28 Activity/Link LED indicators are located at LED1, LED2, LED3, and LED4 on the add-on card. LED1 is used for the SFP28 Port1 connector, LED2 for SFP28 Port2 connector, LED3 for SFP28 Port3 connector, and LED4 for SFP28 Port4 connector. The SIOM LED1-LED4 are all dual bi-level LEDs: the top ones are link indicators and the bottom ones are activity indicators. Refer to the tables below for LED color and definition, and see the layout on page 2-3 for the locations.

LAN Port Activity LED Indicators Assignment/State	
LED	LAN Port Assigned
LED1	SFP28 Port 1 Active
LED2	SFP28 Port 2 Active
LED3	SFP28 Port 3 Active
LED4	SFP28 Port 4 Active
Green	SFP28 LAN Port Active

LAN Port Link LEDs LED State	
LED Color	Definition
Amber	10 Gbps
Green	25 Gbps

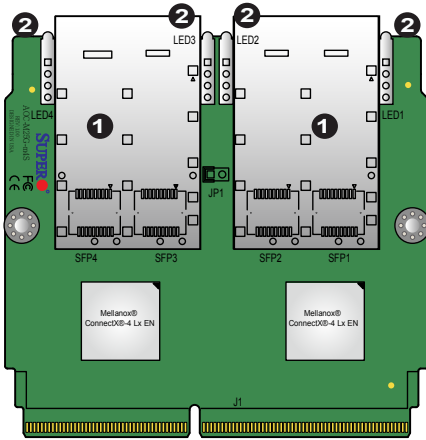

1. SFP28 Connectors
2. SFP28 Link/Activity LED Indicators

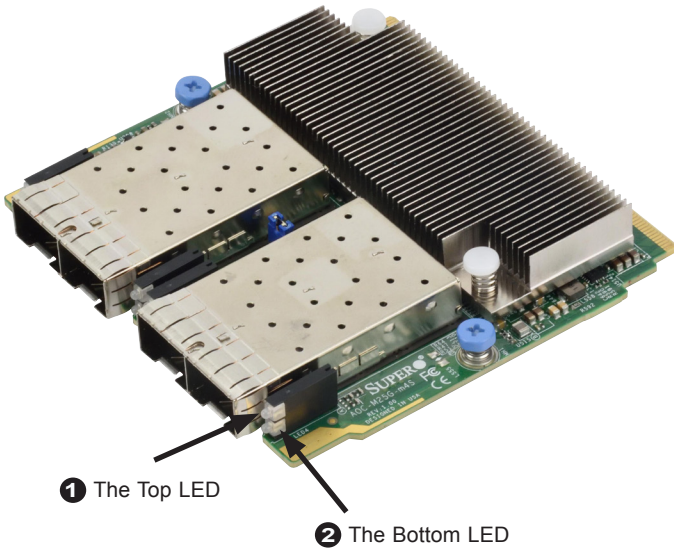

- 1.The Top LED: The Link Indicator
- 2.The Bottom LED: The Activity Indicator



## 2-4 System Management Bus (SMB)

### System Management Bus

System Management Bus is used to monitor critical parameters on the add-on card to enhance overall system performance. SMB is located at JP1. Refer to the layout below for the location of the jumper. The default setting is **ARP**.

SMB Jumper setting	
Jumper Setting	Definition
ON	0x30
OFF	<b>ARP</b>

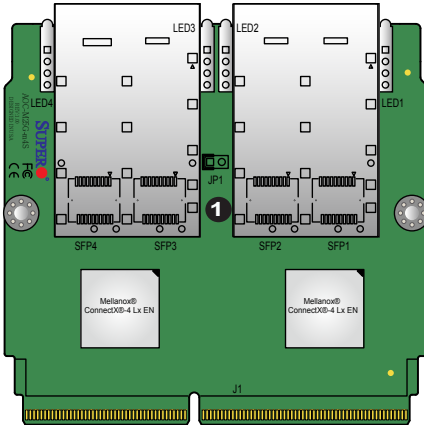

1. System Management Bus

## Chapter 3

### Installation

#### 3-1 Static-Sensitive Devices

Electrostatic Discharge (ESD) can damage electronic components. To avoid damaging your add-on card, it is important to handle it very carefully. The following measures are generally sufficient to protect your equipment from ESD.

##### Precautions

- Use a grounded wrist strap designed to prevent static discharge.
- Touch a grounded metal object before removing the add-on card from the antistatic bag.
- Handle the add-on card by its edges only; do not touch its components.
- Put the add-on card back into the antistatic bags when not in use.
- For grounding purposes, make sure that your system chassis provides excellent conductivity between the power supply, the case, the mounting fasteners and the add-on card.

##### Unpacking

The add-on card is shipped in antistatic packaging to avoid static damage. When unpacking your component or system, make sure you are static protected.



**Note:** To avoid damaging your components and to ensure proper installation, always connect the power cord last, and always unplug it before adding, removing, or changing any hardware components.

### 3-2 Before Installation

Before you install the add-on card, follow the instructions below.

1. Power down the system.
2. Unplug the power cord.
3. Use industry-standard anti-static equipment such as gloves or a wrist strap and follow the precautions on page 3-1 to avoid damage caused by ESD.
4. Familiarize yourself with the server, motherboard, and/or chassis documentation.
5. Confirm that your operating system includes the latest updates and hotfixes.

### 3-3 Installing the Add-on Card

Follow the steps below to install the add-on card into your system.

1. Remove the server cover and, if any, set aside any screws for later use.
2. Remove the add-on card slot cover. If the slot cover has a screw, place it aside for later use.
3. Position the add-on card in front of the SIOM slot and gently push in both sides of the card until it slides into the slot.

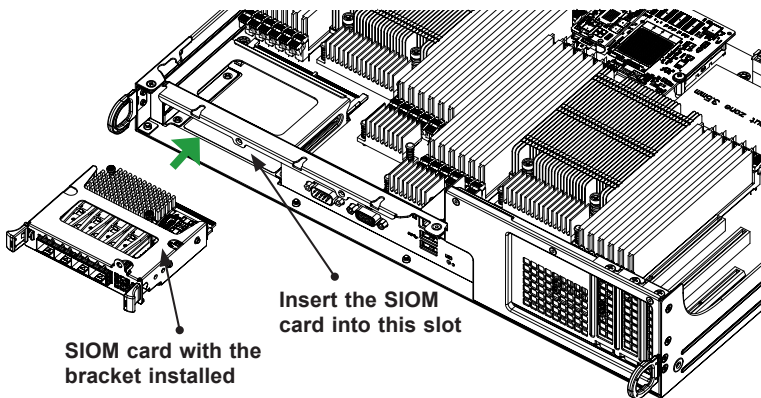

 **Note:** This add-on card does not support hot plug. Please turn off the AC power and remove the power cord from the wall socket before you install or remove the add-on card.

4. Secure the add-on card to the chassis. If required, use the screws that you previously removed.
5. Attach any necessary external cables to the add-on card.
6. Replace the system cover.
7. Plug in the power cord and power up the system.

Follow this step to install the add-on card if your system does not support a swappable bracket. Insert the SIOM card in the motherboard and then install the motherboard in the chassis. An internal bracket comes with the SIOM card 1U in the chassis SKU. It needs to be installed onto the chassis.

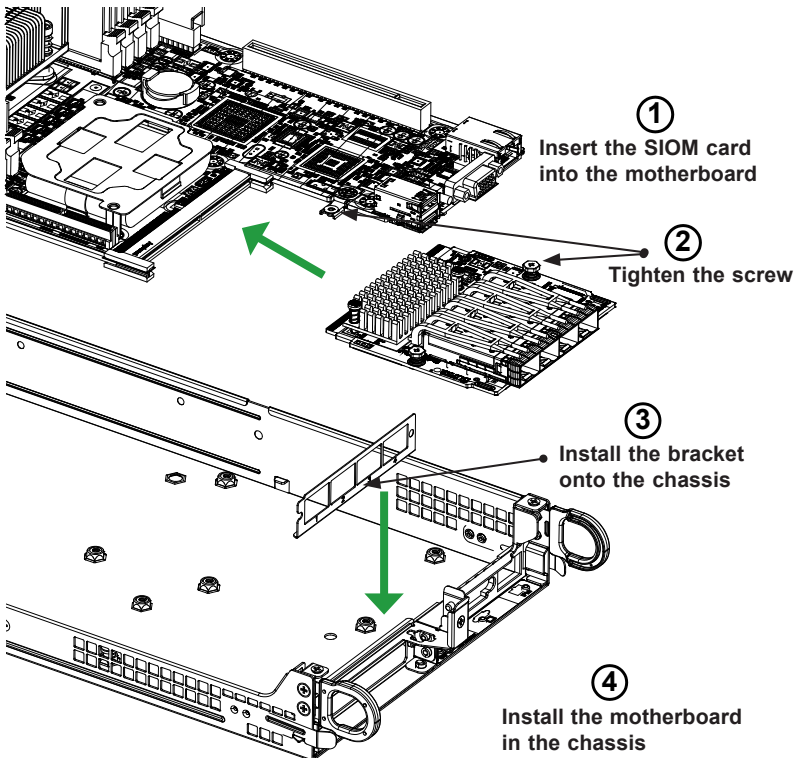

 **Note:** Supermicro recommends that this SIOM card be installed by a system integrator or by the manufacturer.

Follow the steps below to install the add-on card into your system that supports a swappable bracket. The add-on card must be installed in the swappable bracket before it can be installed in the your system

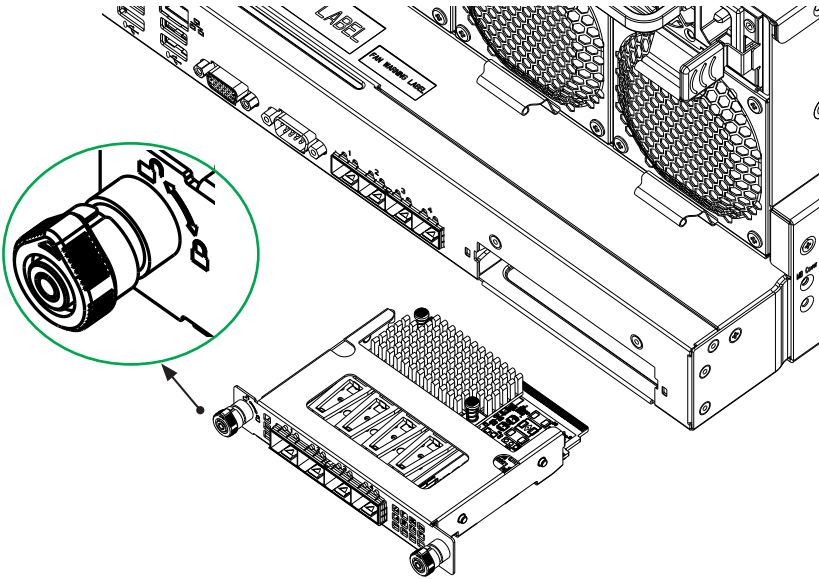

1. Install the add-on card into the swappable bracket.
2. Position the add-on card in front of the SIOM slot and gently push in both sides of the card until it slides into the slot.
3. Once the card is in the slot, push both knobs in and turn to the right to lock the card in the system. The left knob has the unlock/lock symbols next to it. To ensure that the add-on is locked, make sure that the knob position indicator is pointing to the lock symbol.

## 3-4 Installing Drivers (for Mellanox® ConnectX®-4 Lx En)

Use the procedures below to install drivers for Linux.

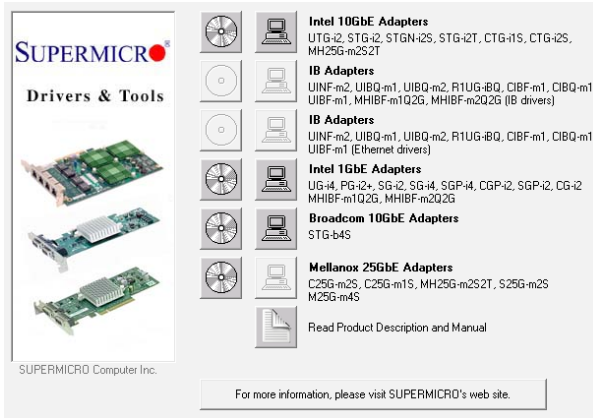

The screenshot shows the SUPERMICRO Drivers & Tools website. On the left, there are images of three network interface cards (NICs) and the text "SUPERMICRO Computer Inc.". On the right, there are several categories of drivers, each with a download icon (a floppy disk or CD) and a laptop icon:

- Intel 10GbE Adapters**: UTG-i2, STG-i2, STGN-i2S, STG-i2T, CTG-i1S, CTG-i2S, MH25G-m2S2T
- IB Adapters**: UIBF-m2, UIBQ-m1, UIBQ-m2, R1UG-iBQ, CIBF-m1, CIBQ-m1, UIBF-m1, MHIBF-m1Q2G, MHIBF-m2Q2G (IB drivers)
- IB Adapters**: UIBF-m2, UIBQ-m1, UIBQ-m2, R1UG-iBQ, CIBF-m1, CIBQ-m1, UIBF-m1 (Ethernet drivers)
- Intel 1GbE Adapters**: UG-i4, PG-i2v, SG-i2, SG-i4, SGP-i4, CGP-i2, SGP-i2, CG-i2, MHIBF-m1Q2G, MHIBF-m2Q2G
- Broadcom 10GbE Adapters**: STG-b4S
- Mellanox 25GbE Adapters**: C25G-m2S, C25G-m1S, MH25G-m2S2T, S25G-m2S, M25G-m4S

Below these categories is a "Read Product Description and Manual" icon. At the bottom, there is a text box: "For more information, please visit SUPERMICRO's web site."

### Linux Drivers

Use the following procedures to install drivers on the Linux operating system.

Installing Mellanox Drivers for the Linux Operating System.

1. Go to Mellanox Support website to download the driver or from the Supermicro website at [https://www.supermicro.com/wftp/Networking\\_Drivers/](https://www.supermicro.com/wftp/Networking_Drivers/), and go to the following directory: Mellanox > 25GbE > Linux.
2. Install the driver by entering the following commands:

```
tar xzvf MLNX_OFED-<ver>.tgz
cd OFED-<ver>
./mlnoxfedinstall --without-fw-update
```

This installs the Linux drivers to your system. For more driver installation information, please refer to Mellanox Support website.

## **Windows Drivers**

Use the following procedures to install drivers on the Windows operating system.

Installing Mellanox Drivers for the Windows Operating System

1. Go to Mellanox Support website to download the driver or from the Supermicro website at [https://www.supermicro.com/wftp/Networking\\_Drivers/](https://www.supermicro.com/wftp/Networking_Drivers/), and go to the following directory: Mellanox > 25GbE > Windows.
2. Choose the desired Windows driver package file.
3. Double-click to run and install the driver package file.

### 3-5 Configuring EFI mode from System Setup

During the host boot process, EFI mode configuration can be modified through BIOS setup.

1. From the top of the tool bar, select Advanced to enter the submenu. Choose PCIe/PCI/PnP Configuration and press <Enter> to see the contents of PCI devices settings.

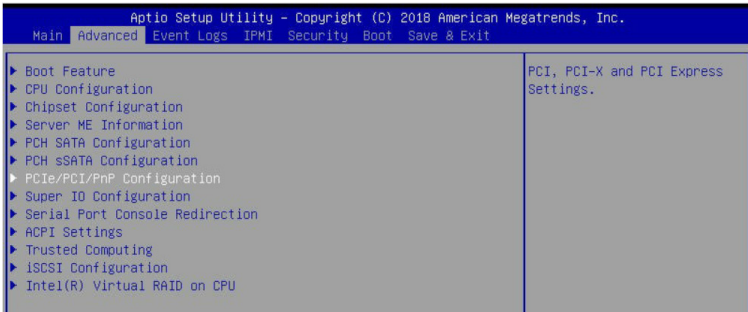

2. When the screen as shown below displays, use the arrow keys to select SIOM CPU1 PCI-E 3.0 x16 OPROM and press <Enter>. Use this feature to select which firmware type to be loaded for the add-on card in this slot. The options are Disabled, **Legacy**, and **EFI**. Select **EFI** and press <Enter>. To save the setting, select Save Changes and Reset from the Save & Exit menu and press <Enter>.

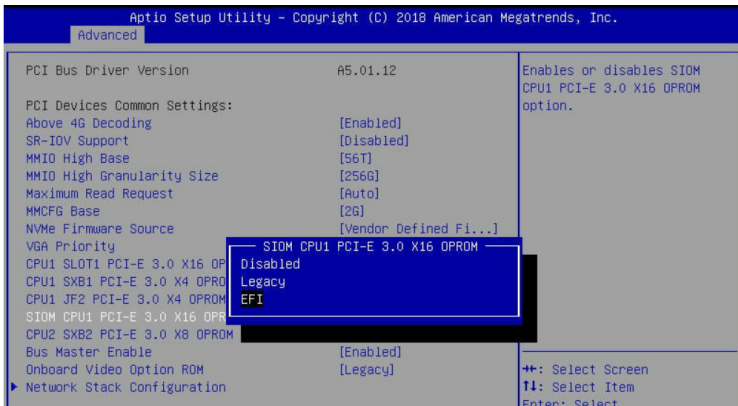



3. To see the available boot options of the UEFI Network Drive, select Boot to enter the submenu. When the following screen appears, use the arrow keys to select UEFI NETWORK Drive BBS Priorities and press <Enter>.

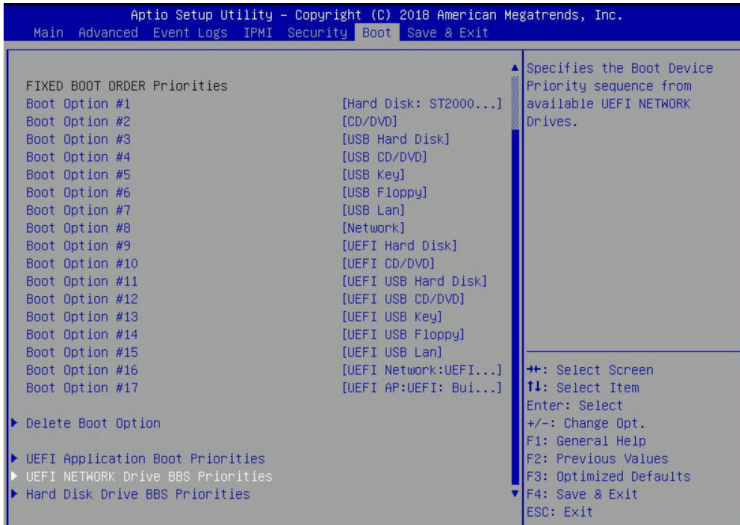

4. To examine the details of each boot option, select the corresponding numbers of the desired boot options. For example, when Boot Option #1 is selected, the MAC address of the Boot Option #1 page will appear.

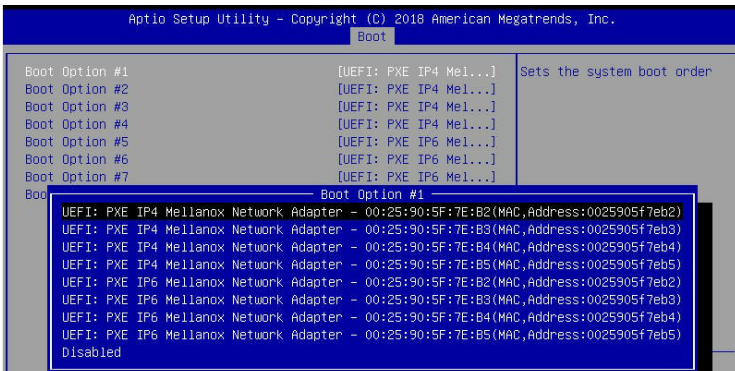

5. After the system configuration is completed, select Save Changes and Reset from the Save & Exit menu and press <Enter> to save the changes made.

```

Aptio Setup Utility - Copyright (C) 2018 American Megatrends, Inc.
Main Advanced Event Logs IPMI Security Boot Save & Exit

Save Options
Discard Changes and Exit
Save Changes and Reset
Save Changes
Discard Changes

Default Options
Restore Optimized Defaults
Save as User Defaults
Restore User Defaults

Boot Override
ISATA P6: ST2000NX0253
UEFI: PXE IP4 Mellanox Network Adapter - 00:25:90:5F:7E:B2
UEFI: PXE IP4 Mellanox Network Adapter - 00:25:90:5F:7E:B3
UEFI: PXE IP4 Mellanox Network Adapter - 00:25:90:5F:7E:B4
UEFI: PXE IP4 Mellanox Network Adapter - 00:25:90:5F:7E:B5
UEFI: PXE IP6 Mellanox Network Adapter - 00:25:90:5F:7E:B2
UEFI: PXE IP6 Mellanox Network Adapter - 00:25:90:5F:7E:B3
UEFI: PXE IP6 Mellanox Network Adapter - 00:25:90:5F:7E:B4
UEFI: PXE IP6 Mellanox Network Adapter - 00:25:90:5F:7E:B5
UEFI: Built-in EFI Shell

Reset the system after
saving the changes.

+/: Select Screen
↑↓: Select Item
Enter: Select
+/-: Change Opt.
F1: General Help
F2: Previous Values
F3: Optimized Defaults
F4: Save & Exit
ESC: Exit

```

 **Note:** All screenshots shown are for illustration purpose only and may not match the screens that you see on your system.