



## WEEE DISASSEMBLY INSTRUCTIONS

### SUPERMICRO SYS-511E-WR ENCLOSURE

#### **Abstract**

This document provides clear guidance for end-of-life recyclers on how to identify and disassemble reportable materials in compliance with the Waste Electrical and Electronic Equipment (WEEE) directive.

# Table of Contents

1.	Product Views.....	1
2.	Reportable Materials on SYS-511E-WR .....	3
3.	Disassemble Instructions .....	3
	3.3 Step-by-Step Disassembly Instructions .....	7
1.	Removing Cable and Chassis Top Cover .....	7
2.	Removing Hard Disk Drive (HDDD) / Solid State Drive (SDD) .....	8
3.	Removing Power Supply .....	9
4.	Removing Power Distributor.....	10
5.	Removing Backplane .....	11
6.	Removing Fan .....	11
7.	Removing the Air shroud, Riser, and the Riser Bracket .....	12
8.	Removing Processor .....	13
9.	Removing DIMM.....	14
10.	Removing the M.2 from the Motherboard .....	15
11.	Removing Add-On Module .....	15
12.	Removing Motherboard.....	16

# 1. Product Views

Front view



Rear view

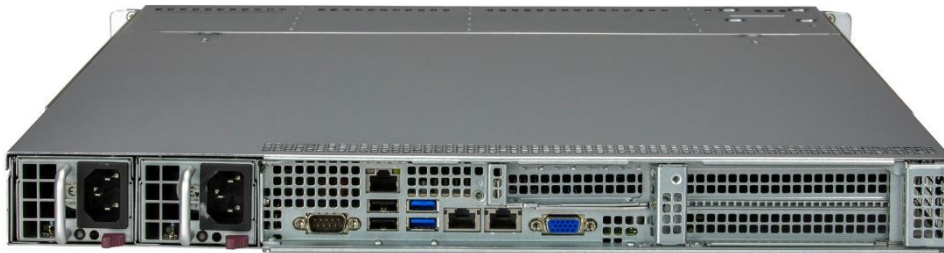

Product construct view

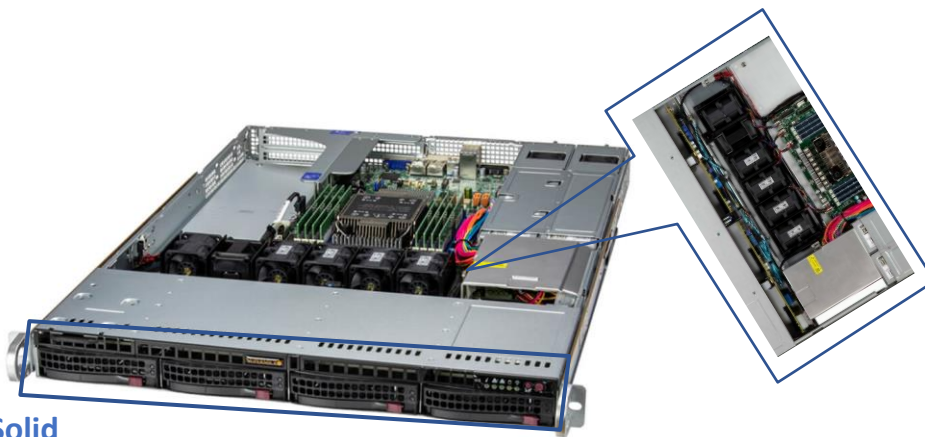

Hard Disk Drive/ Solid State Drive



Backplane

Fans

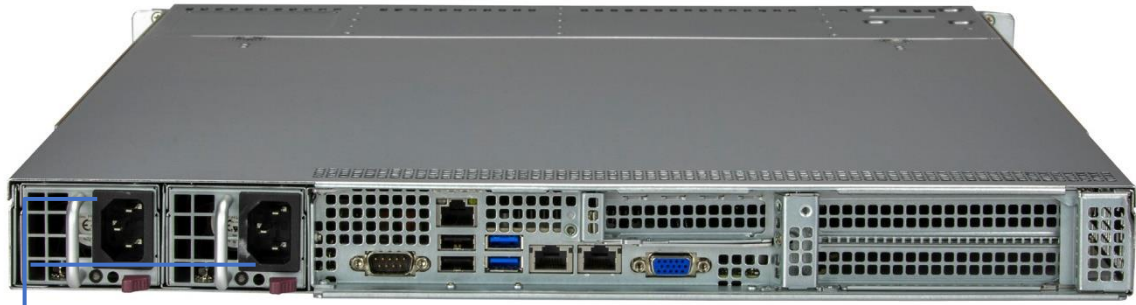

Power Supply

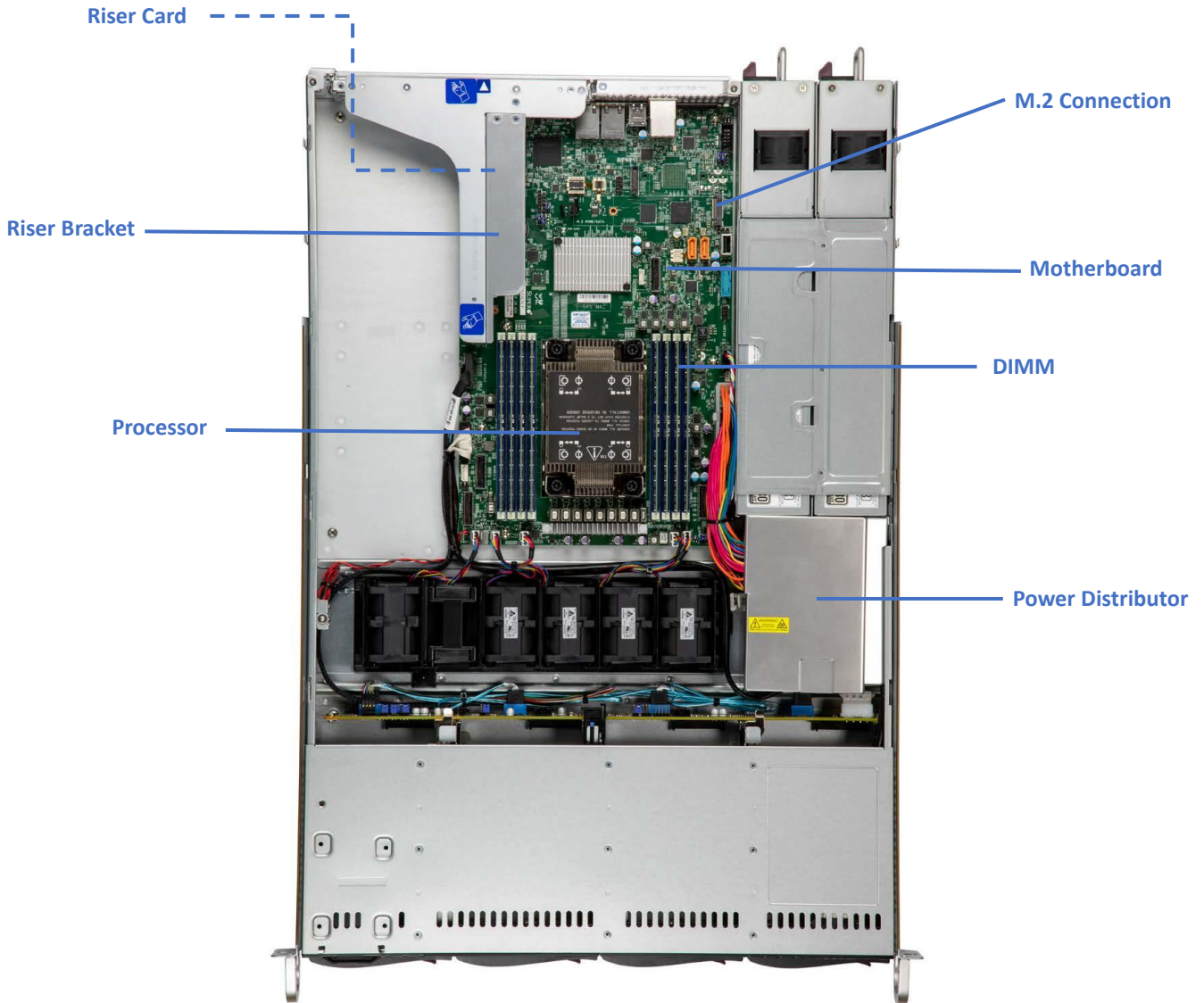

## 2. Reportable Materials on SYS-511E-WR

According to Article 8(2) and Annex VII of WEEE directive 2012/19/EU, Below materials and components should be selectively treated.

Description	Notes	No.	Quantity
Printed Circuit Boards (PCB) or Printed Circuit Assemblies (PCA)	With a surface greater than 10 sq cm	2.4, 3.5, 4.2, 5.1, 7.2, 8.2, 9.1, 10.1, ,11.1,12.1,13.2	17
Batteries	All types, including standard alkaline and lithium coin or button style batteries	12.2	1
Mercury-containing components	For example, mercury in lamps, display backlights, scanner lamps, switches, batteries		
Liquid Crystal Displays (LCD) with a surface greater than 100 sq cm	Includes background illuminated displays with gas discharge lamps		
Cathode Ray Tubes (CRT)			
Capacitors / condensers (Containing PCB/PCT)			
Electrolytic Capacitors / Condensers measuring greater than 2.5 cm in diameter or height	Depending on the power supply model	3.6	2
External electrical cables and cords		1.1	2
Gas Discharge Lamps			
Plastics containing Brominated Flame Retardants		13.1	1
Components and parts containing toner and ink, including liquids, semi-liquids (gel/paste), and toner	Include the cartridges, print heads, tubes, vent chambers, and service stations.		
Components and waste containing asbestos			
Components, parts, and materials containing refractory ceramic fibers			
Components, parts, and materials containing radioactive substances			

## 3. Disassemble Instructions



The intent of this document is to provide guidance to recyclers on the presence of materials and

components at the product / family level, as required by the EU WEEE Directive 2012/10/EU. This document should also help direct recyclers to proper methods for removing parts and general product disassembly instructions.

This chapter consists of three subsections:







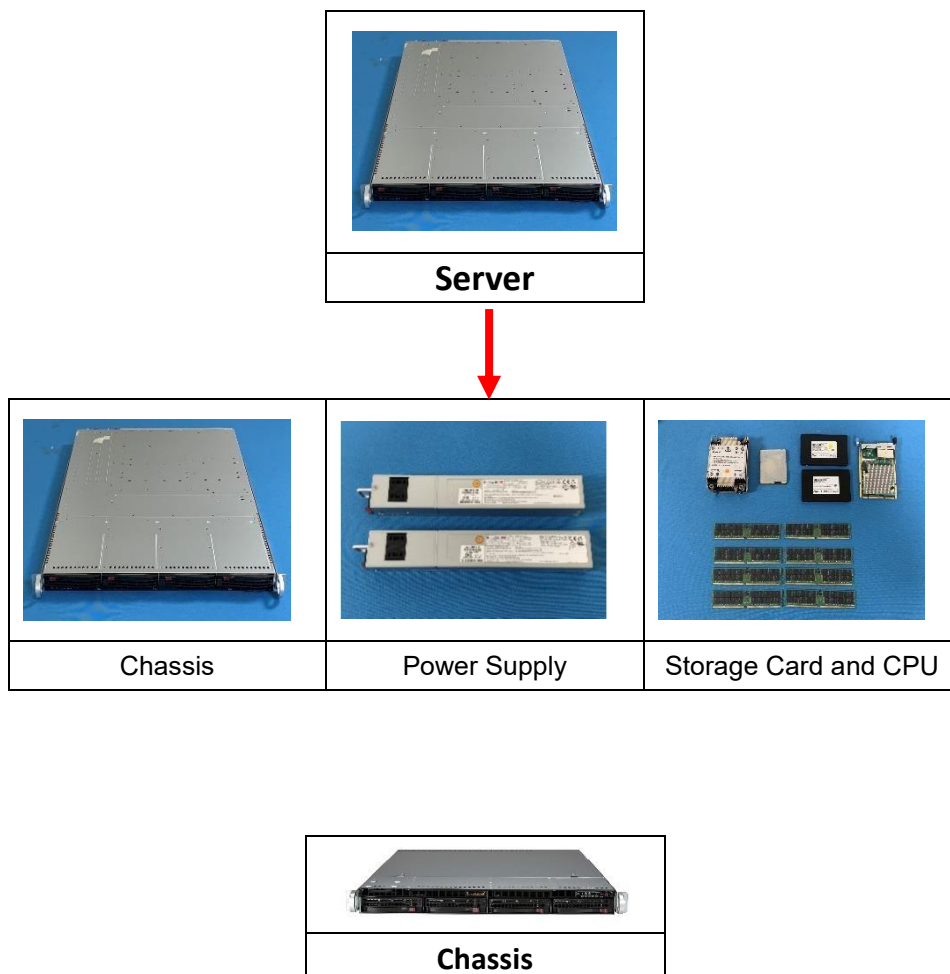

Recommended disassembly tools, disassembled flowchart, and step-by-step disassembly instructions to direct recycler proper methods to treat.

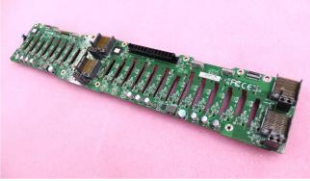
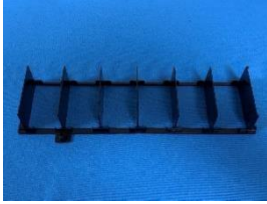
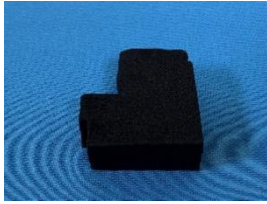
### 3.1 Recommended Disassembly Tools

<b>Disassembly tool</b>	Cross screwdriver	
	Flathead screwdriver	

### 3.2 Disassembled flowchart



			
Backplane	Fan Holder	Sponge	Fan
			
Screw, Stand-off	Motherboard, Riser Card, and Power Distributor	Storage Controller Card	Air Shroud
			
Power Distributor Cover	Cable	Battery	



Power Enclosure*2	Screw and Standoff*2 Set	Power Supply Module*2	Power Distributor*1

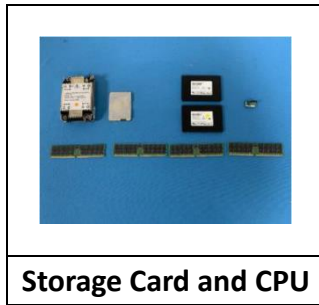

Heat Sink	Processor	SSD
TPM	DIMM	Power Cable
M.2		



### 3.3 Step-by-Step Disassembly Instructions

#### 1. Removing Cable and Chassis Top Cover

1. Use the operating system to power down the system.
2. After the system has completely shut-down, disconnect the power cords from the power supply modules.
3. Remove all cables/ unit from the server IO port.

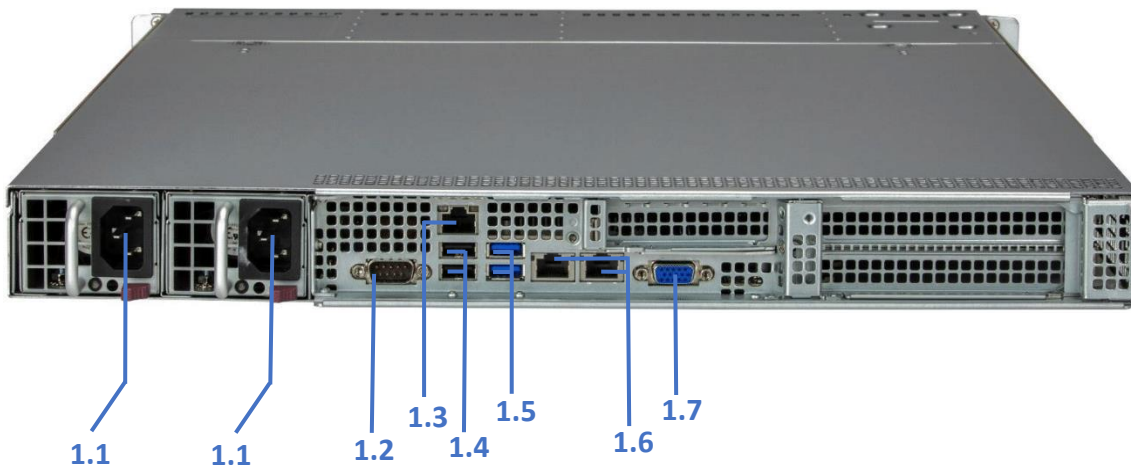

4. The chassis top cover can be lifted off after pressing down on release buttons and sliding the cover off.

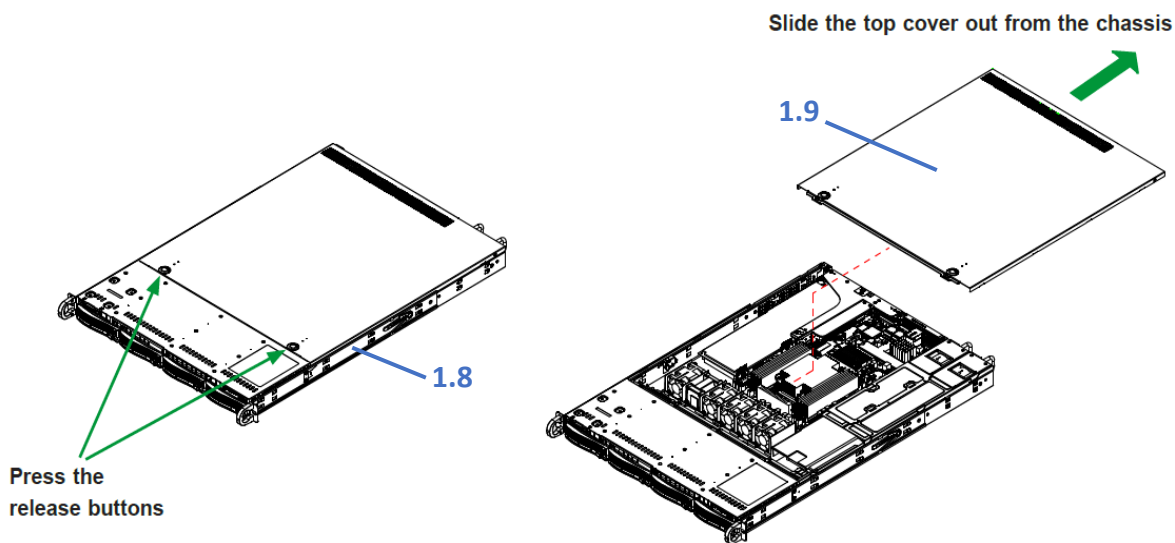

No.	Description	No.	Description
<a href="#">1.1</a>	Power Cable	1.6	LAN Ports
1.2	Serial Port	1.7	VGA Port
1.3	BMC LAN Port	1.8	Chassis
1.4	USB 2.0 Ports	1.9	Top Cover
1.5	USB 3.2 Gen 1 Ports		

## 2. Removing Hard Disk Drive (HDDD) / Solid State Drive (SDD)

1. Press the release tab to release the drive carrier from its locking position
2. Pull the drive carrier out from the chassis as shown below:

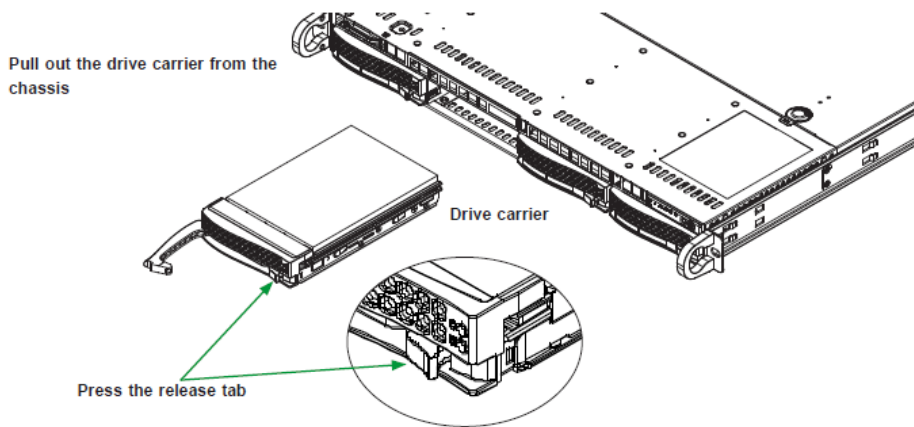

3. Remove the dummy tray insert by first removing two screws, then pull out the dummy tray

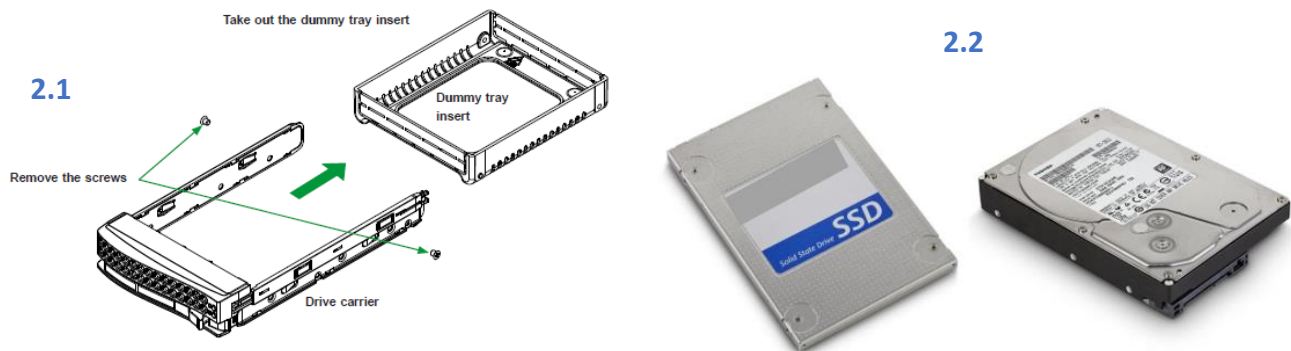

5. Use a cross screwdriver to remove drive enclosure

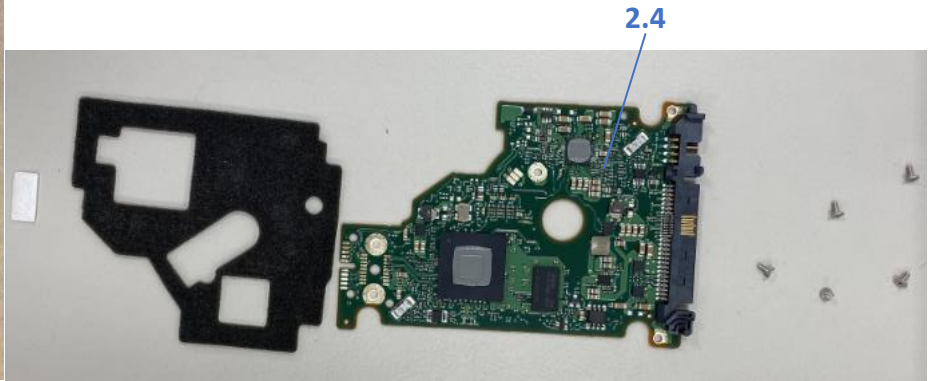

6. Use a cross screwdriver to remove screws and lift off the PCB

No.	Description
2.1	Dummy Tray
2.2	HDD/ SSD
2.3	Hard Drive Enclosure
<a href="#">2.4</a>	Hard Drive PCB

### 3. Removing Power Supply

1. Press the release tab on the power supply.
2. Use the handle to gently slide the power supply out the back of the chassis.

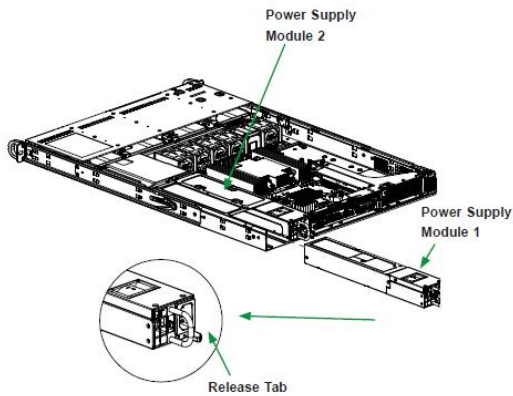

3. Remove the screw from the enclosure



4. Disconnected to the fan and lift the main board from the chassis by hand

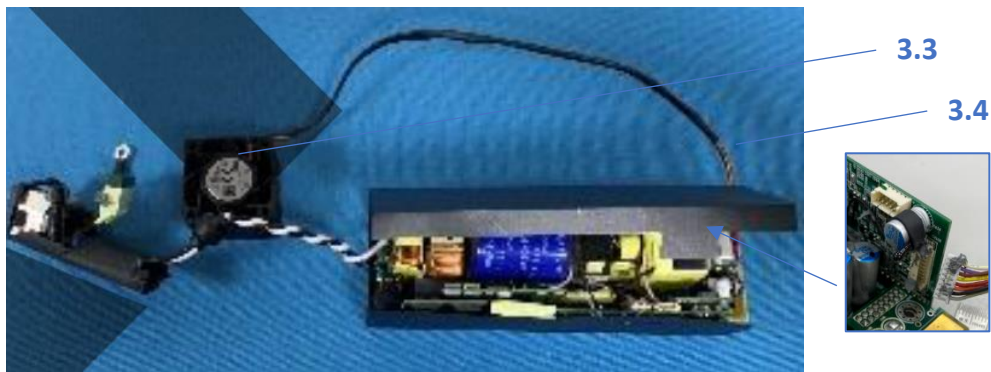

5. Use a flathead screwdriver to cut the capacitor adhesive and pin solder.



No.	Description
3.1	Power Supply
3.2	Power Enclosure
3.3	Fan
3.4	Fan Cable
<a href="#">3.5</a>	Power Module PCB
<a href="#">3.6</a>	Capacitor

#### 4. Removing Power Distributor

1. Disconnect the power cords from the power supply modules.
2. Remove the cover from the power distributor.
3. Unplug the power distributor from the motherboard and backplane.
4. Remove 4 screws and lift out the power distributor from the chassis
5. Remove power distributor screw and standoff then take PCB from the power distributor.

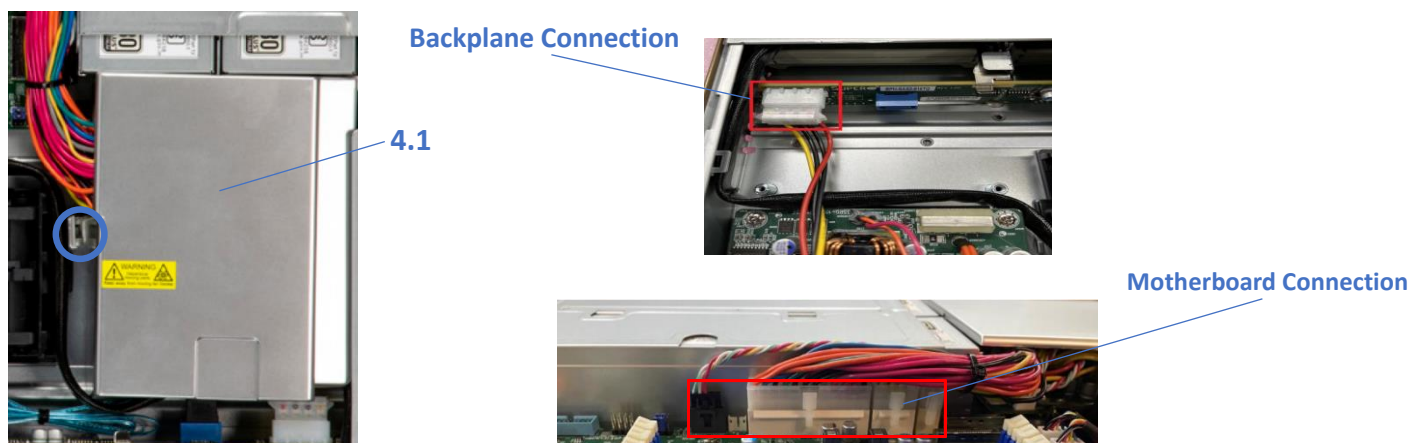

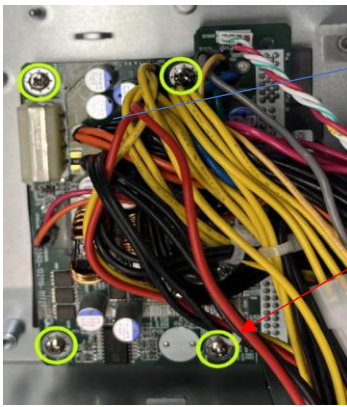

4.2  
Remove screw and standoffs

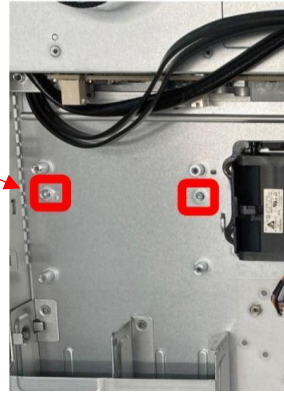

No.	Description
4.1	Power Distributor Cover
<a href="#">4.2</a>	Power Distributor PCB

## 5. Removing Backplane

1. Remove the backplane's 2 screws from the chassis and then remove backplane from chassis.



5.1

No.	Description
<a href="#">5.1</a>	Backplane

## 6. Removing Fan

1. Disconnect the chassis fan from the motherboard fan connectors and lift fans out of chassis.



6.1

No.	Description
6.1	Cooling Fans

## 7. Removing the Air shroud, Riser, and the Riser Bracket

1. Lift the air shroud out of the chassis by hand
2. Remove screws each from the riser card bracket
3. Take the riser card and bracket away from the chassis
4. Unscrew the two screws holding each riser card to remove riser cards from bracket.

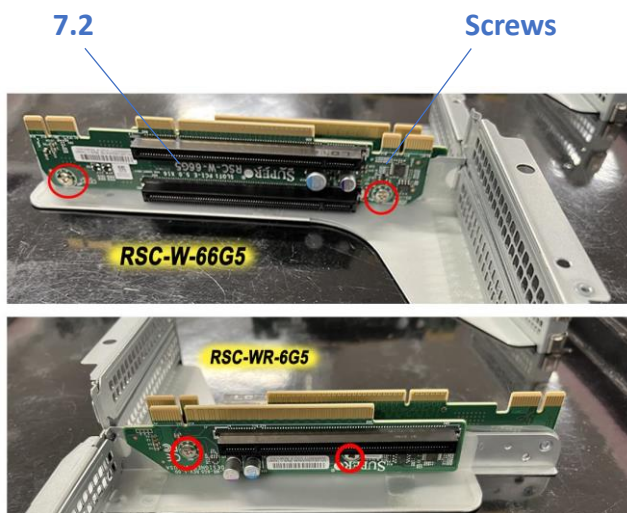
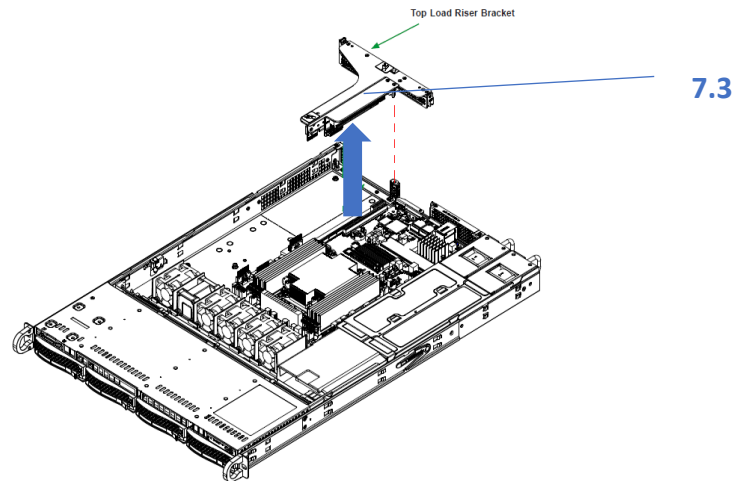
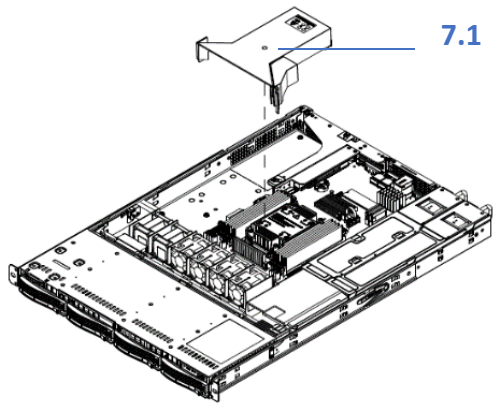

No.	Description
7.1	Air shroud
<a href="#">7.2</a>	Riser Cards
7.3	Riser Bracket

## 8. Removing Processor

1. Removing the PHM (Processor Heatsink Module ) from the motherboard, first shut down the system and unplug the AC power cord from all power supplies
2. Use a T30-bit screwdriver to loosen the four peek nuts on the heatsink in the sequence of A, B, C, and D

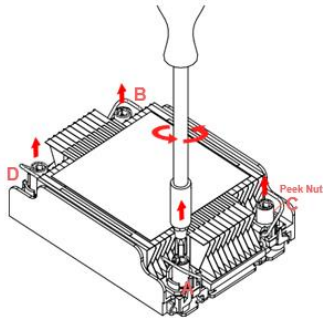

3. Once the peek nuts have been loosened from the CPU socket, press the rotating wires inward to unlatch the PHM from the socket, as shown below

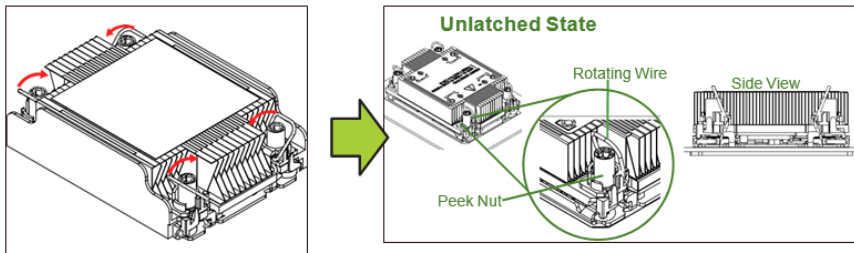

4. Gently lift the PHM upward to remove it from the CPU socket

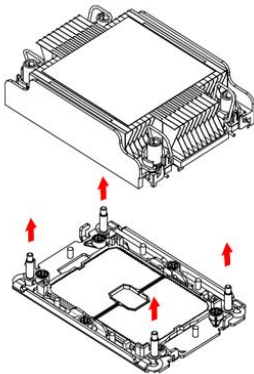

5. Use your hand to detach the four plastic clips (marked a, b, c, d) on the processor carrier assembly from the four corners of the heatsink (marked A, B, C, D), as shown below

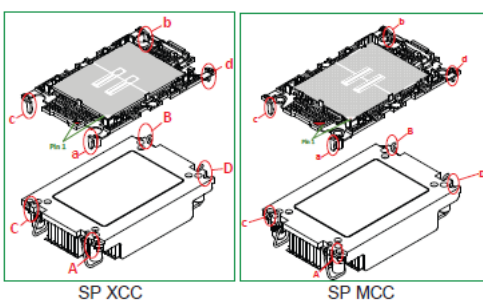

6. When all plastic clips have been detached from the heatsink, remove the processor carrier assembly from the heatsink

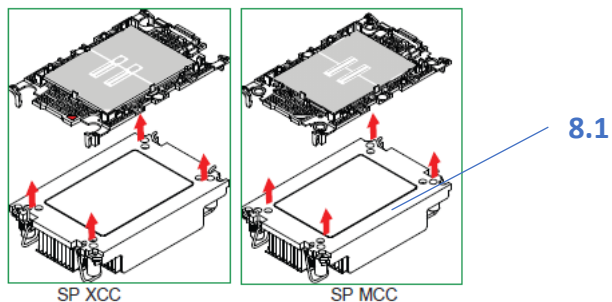

7. Unlock the lever from its locked position and push it upwards to disengage the processor from the processor carrier, as shown below right

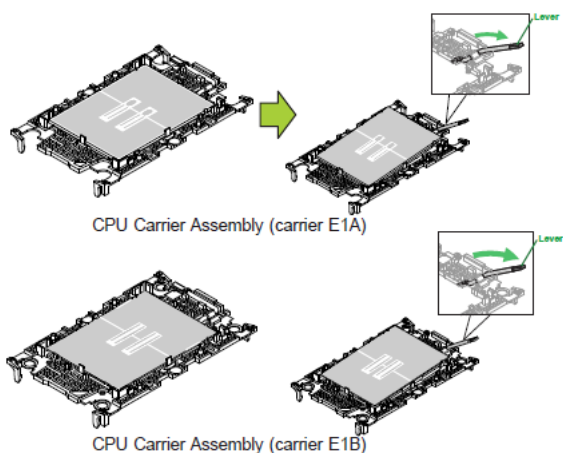

8. Once the processor has been loosened from the carrier, carefully remove the processor from the carrier

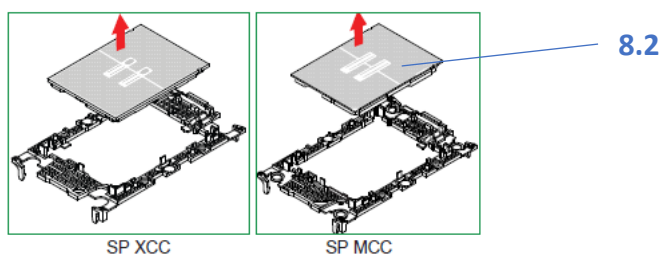

**Note:** Please handle the processor with care to avoid damaging it or its pins

No.	Description
8.1	Heat Sink
<a href="#">8.2</a>	Processor

## 9. Removing DIMM

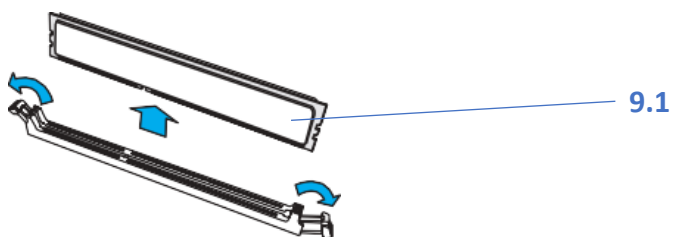



1. Hand press both release tabs on the ends of the DIMM module to unlock it
2. Once the DIMM module is loose, remove it from the memory slot

No.	Description
<a href="#">9.1</a>	DIMM

## 10. Removing the M.2 from the Motherboard

1. Locate the M.2 on the motherboard and remove the screw for the M.2.
2. Gently remove the M.2 from the Motherboard.

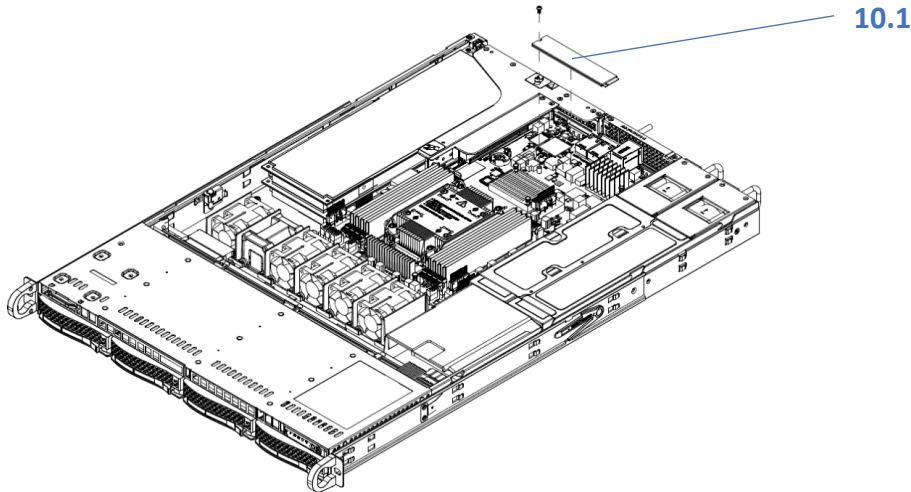

No.	Description
<a href="#">10.1</a>	M.2

## 11. Removing Add-On Module

1. Locate the Add-On Module on the motherboard near the JTPM and remove gently by hand by pulling upwards.

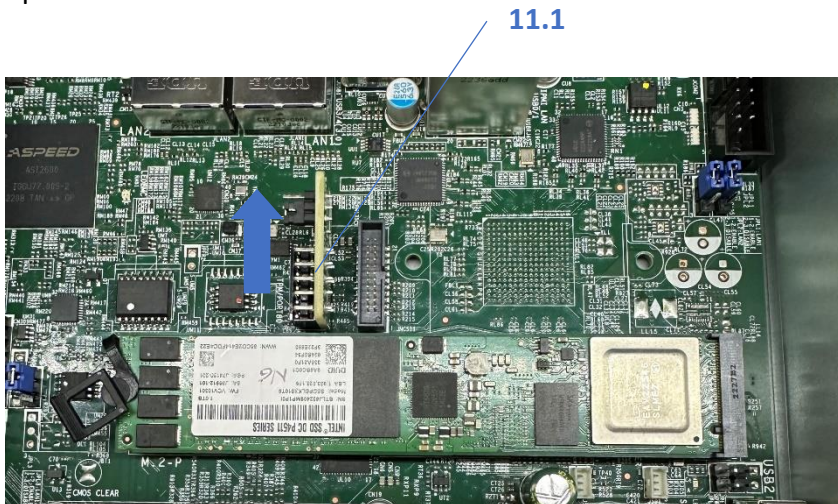

No.	Description
<a href="#">11.1</a>	Add-On Module

## 12. Removing Motherboard

1. Remove screws, lift out motherboard
2. Push aside the small clamp that covers the edge of the battery. When the battery is released, lift it out of the holder.
3. When the motherboard is removed, the node enclosure can be recycled

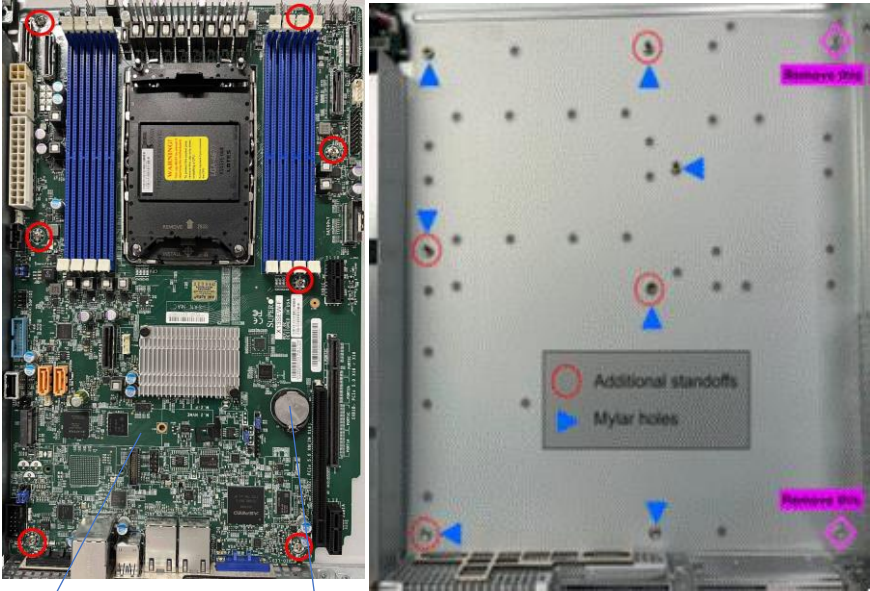

12.1

12.2

LITHIUM BATTERY

BATTERY HOLDER

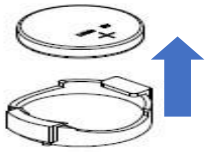

No.	Description
<a href="#">12.1</a>	Motherboard
<a href="#">12.2</a>	Battery

## 13. Removing Control Board

1. Remove control board screws then lift the control board cover (red)

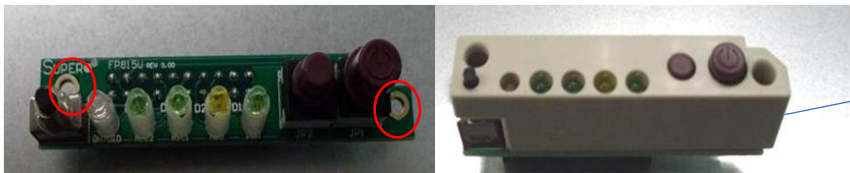

13.1

No.	Description
<a href="#">13.1</a>	Control Board Cover
<a href="#">13.2</a>	Control Board