



WEEE DISASSEMBLY INSTRUCTIONS

SUPERMICRO AS -1125HS-TNR ENCLOSURE

Abstract

This document provides clear guidance for end-of-life recyclers on how to identify and disassemble reportable materials in compliance with the Waste Electrical and Electronic Equipment (WEEE) directive.

Table of Contents

1.	Product Views.....	1
2.	Reportable Materials on AS -1125HS-TNR	3
3.	Disassemble Instructions	4
	3.3 Step-by-Step Disassembly Instructions	6
1.	Removing Cable and Chassis Top Cover	6
2.	Removing Hard Disk Drive (HDD) / Solid State Drive (SDD)	7
3.	Removing Power Supply	9
4.	Removing Advanced I/O (AIOM) Network Card	11
5.	Removing AIOM Cable	11
6.	Removing Add-on Module (AOM)	12
7.	Removing Fan	12
8.	Removing Backplane	12
9.	Removing the Riser Bracket and Riser Card	13
10.	Removing Processor	14
11.	Removing DIMM.....	15
12.	Removing the Network Card.....	15
13.	Removing the M.2 from the Motherboard	15
14.	Removing the Power Supply Shroud and Air Shroud.....	16
15.	Removing Motherboard.....	17

1. Product Views

Front view



Rear view



Product construct view



Hard Disk Drive/ Solid State Drive

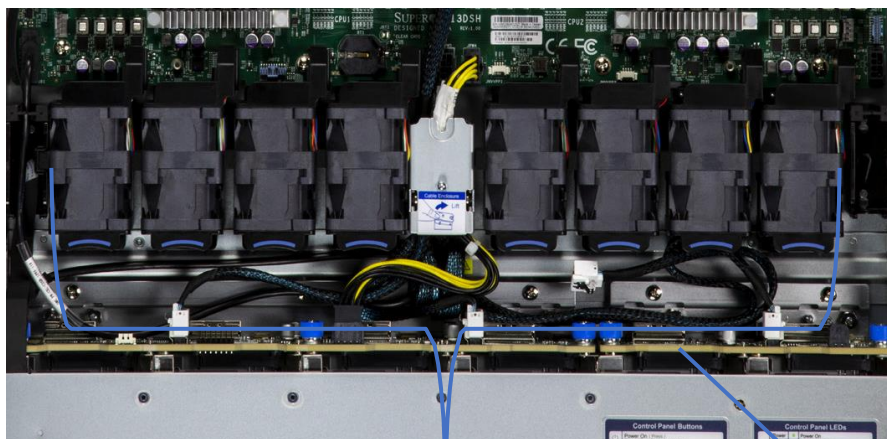

Fans

Backplane



Power Supply

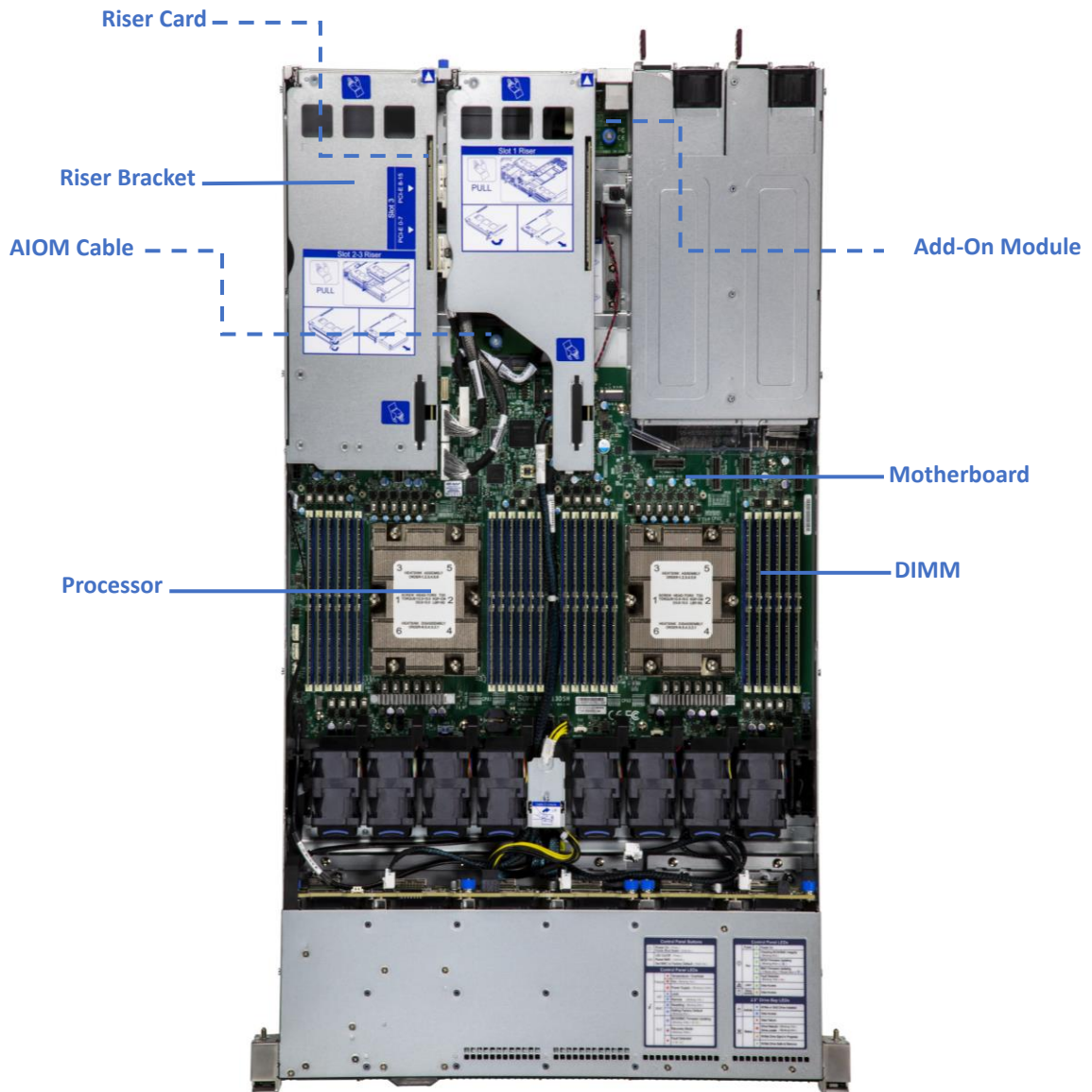

2. Reportable Materials on AS -1125HS-TNR

According to Article 8(2) and Annex VII of WEEE directive 2012/19/EU, Below materials and components should be selectively treated.

Description	Notes	No.	Quantity
Printed Circuit Boards (PCB) or Printed Circuit Assemblies (PCA)	With a surface greater than 10 sq cm (Depending on the product configuration)	2.3, 3.5, 4.1, 5.1, 6.1, 8.1, 9.2, 10.2, 11.1, 12.1, 13.1, 15.1	49
Batteries	All types, including standard alkaline and lithium coin or button style batteries	15.2	1
Mercury-containing components	For example, mercury in lamps, display backlights, scanner lamps, switches, batteries		
Liquid Crystal Displays (LCD) with a surface greater than 100 sq cm	Includes background illuminated displays with gas discharge lamps		
Cathode Ray Tubes (CRT)			
Capacitors / condensers (Containing PCB/PCT)			
Electrolytic Capacitors / Condensers measuring greater than 2.5 cm in diameter or height	Depending on the power supply model	3.6	2
External electrical cables and cords		1.1	2
Gas Discharge Lamps			
Plastics containing Brominated Flame Retardants			
Components and parts containing toner and ink, including liquids, semi-liquids (gel/paste), and toner	Include the cartridges, print heads, tubes, vent chambers, and service stations.		
Components and waste containing asbestos			
Components, parts, and materials containing refractory ceramic fibers			
Components, parts, and materials containing radioactive substances			



3. Disassemble Instructions

The intent of this document is to provide guidance to recyclers on the presence of materials and components at the product / family level, as required by the EU WEEE Directive 2012/10/EU. This document should also help direct recyclers to proper methods for removing parts and general product disassembly instructions.

This chapter consists of three subsections:





Recommended disassembly tools, disassembled flowchart, and step-by-step disassembly instructions to direct recycler proper methods to treat.

3.1 Recommended Disassembly Tools

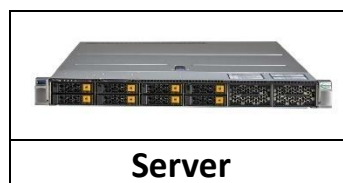
Disassembly tool	Cross screwdriver	
	Flathead screwdriver	

3.2 Disassembled flowchart

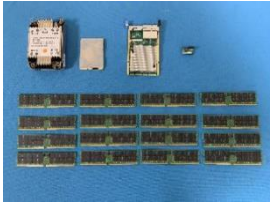

			
Chassis	Power Supplies	RAM, CPU, Heatsink, AIOM Card	Power Cords

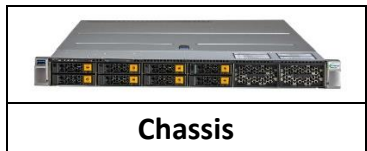

Chassis





			
Backplane	Fans	Screws	Motherboard, Riser Cards, Backplane, Add-On Module, AIOM Cable
			
Battery	Cables	Power Supply Air Shroud	





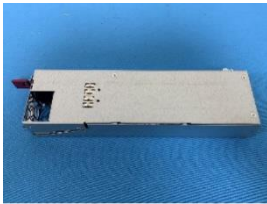

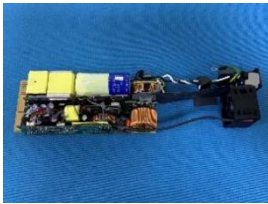

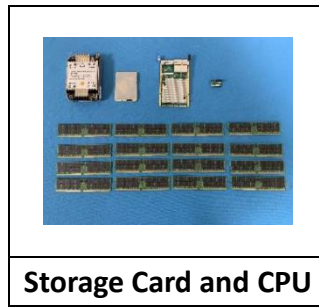
Power Supply



		
Power Enclosure*2	Screws and Standoff*2 Set	Power Supply Module*2

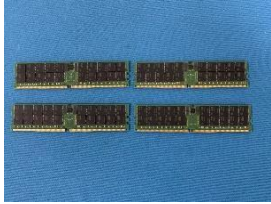

			
Heat Sink	Processor	SSD *6set	M.2 *2
			
Network Card *4	DIMM *6Set	AIOM Card	Add-On Module

3.3 Step-by-Step Disassembly Instructions

1. Removing Cable and Chassis Top Cover

1. Use the operating system to power down the system.
2. After the system has completely shut-down, disconnect the power cords from the power supply modules.
3. Remove all cables/ unit from the server IO port.

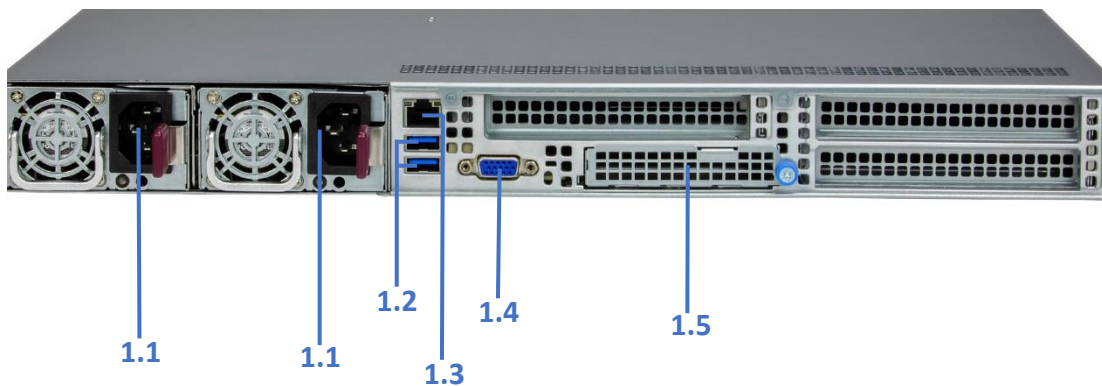

4. The chassis top cover can be lifted off after pressing down on the release button and lifting the cover off.

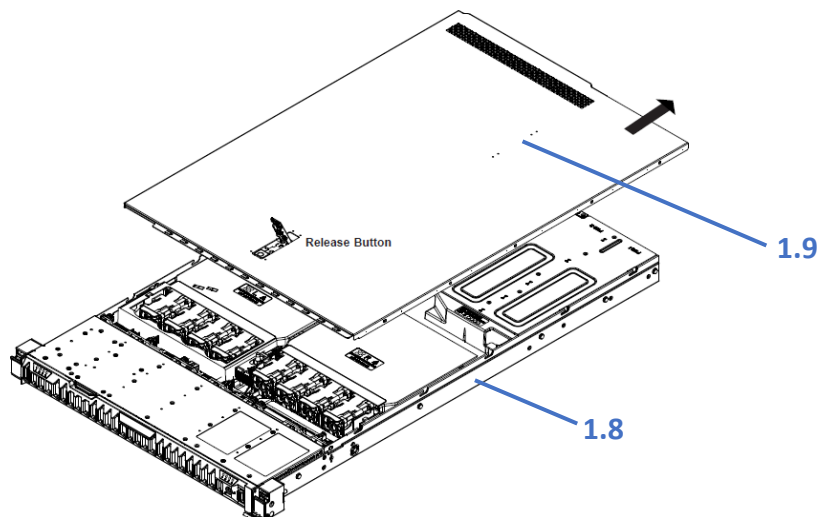

No.	Description	No.	Description
1.1	Power Cable	1.8	Chassis
1.2	USB 3.0 Ports	1.9	Top Cover
1.3	BMC LAN Port		
1.4	VGA Port		
1.5	PCIe 5.0 x16 AIOM Slot (NCSI)		

2. Removing Hard Disk Drive (HDD) / Solid State Drive (SDD)

1. Press the release button to extend the drive carrier handle.
2. Use the drive carrier handle to pull the drive out of the chassis.

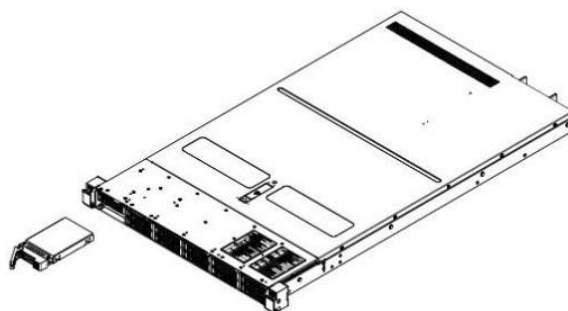
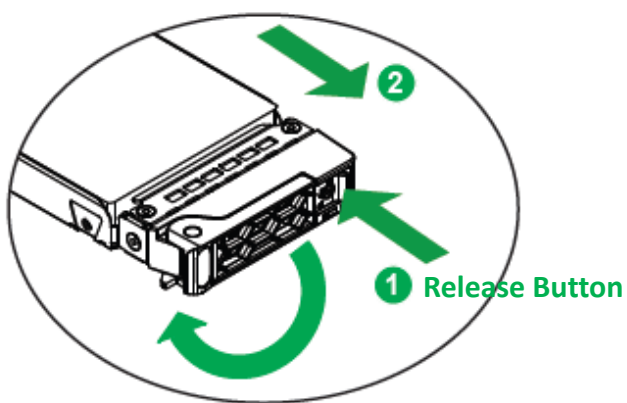

3. Unscrew the two screws holding the drive in place.

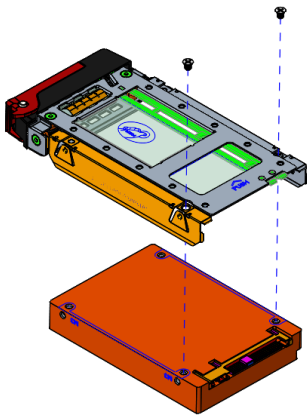

2.1

4. Push the drive from the opening below (circled in red) to release the drive from the tray.



5. Use a cross screwdriver to remove the drive enclosure



2.2

6. Use a cross screwdriver to remove screws and lift off the PCB

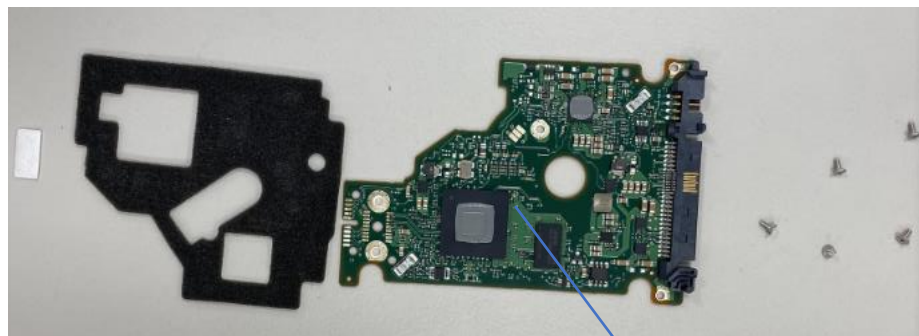

2.3

No.	Description
2.1	HDD/ SSD
2.2	Hard Drive Enclosure
2.3	Hard Drive PCB

3. Removing Power Supply

1. Push the release tab back on the power supply.
2. Use the handle to gently slide the power supply out the back of the chassis.

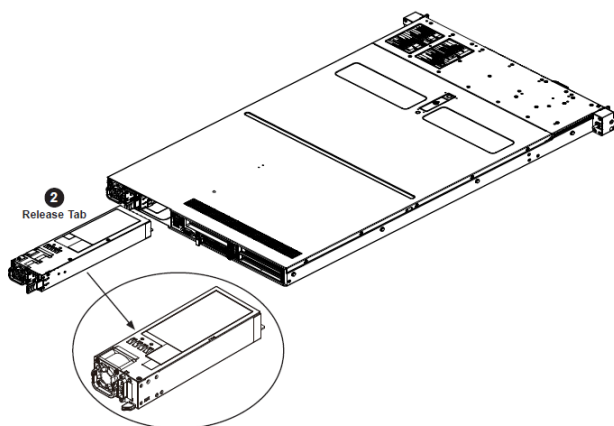

3.2

3. Remove the screw from the enclosure



3.1

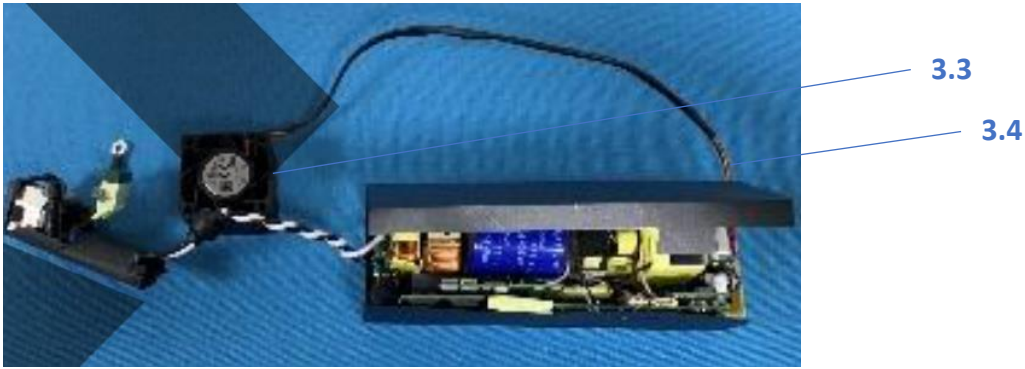

4. Cut the power leads connected to the fan and lift the main board from the chassis

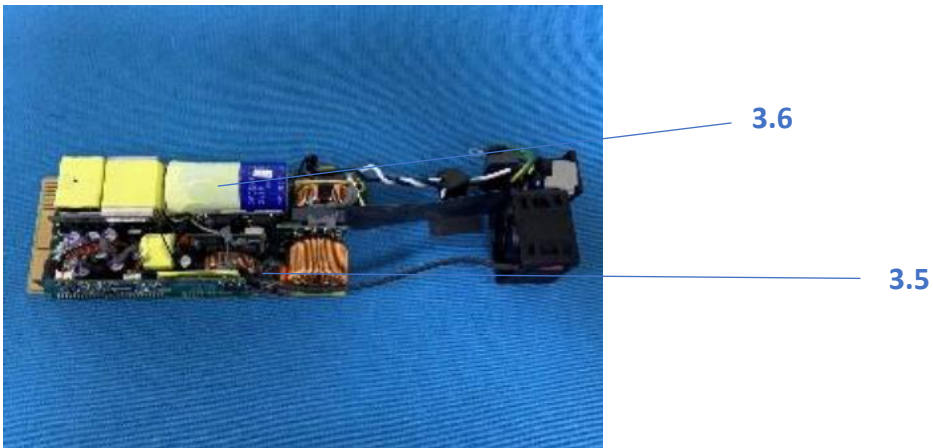

5. Use a flathead screwdriver to cut the capacitor adhesive and pin solder.



No.	Description
3.1	Power Supply
3.2	Power Enclosure
3.3	Fan
3.4	Fan Cable
3.5	Power Module PCB
3.6	Capacitor

4. Removing Advanced I/O (AIOM) Network Card

1. Loosen the thumbscrew (circled in red) using your hand.



2. Slide the AIOM out of the opening.

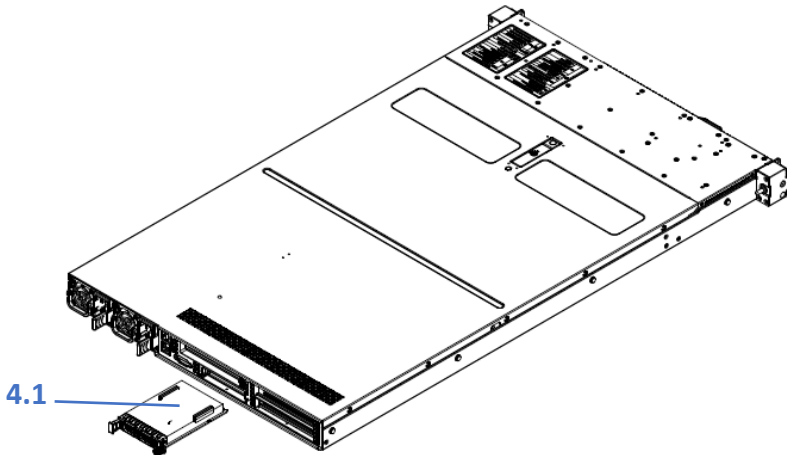

No.	Description
4.1	AIOM Network Card

5. Removing AIOM Cable

1. Unscrew the two screws (circled in red) using a screwdriver and loosen the thumb screw by hand.
 2. Remove the cable from the motherboard.

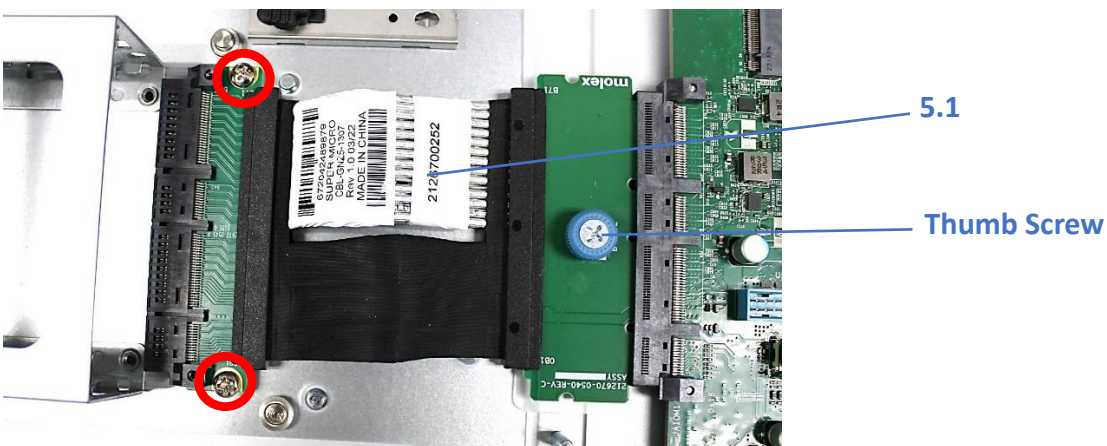

No.	Description
5.1	AIOM Cable

6. Removing Add-on Module (AOM)

1. Loosen the thumbscrew shown below.
2. Slide the AOM away from the rear and then lift the AOM out of the system.

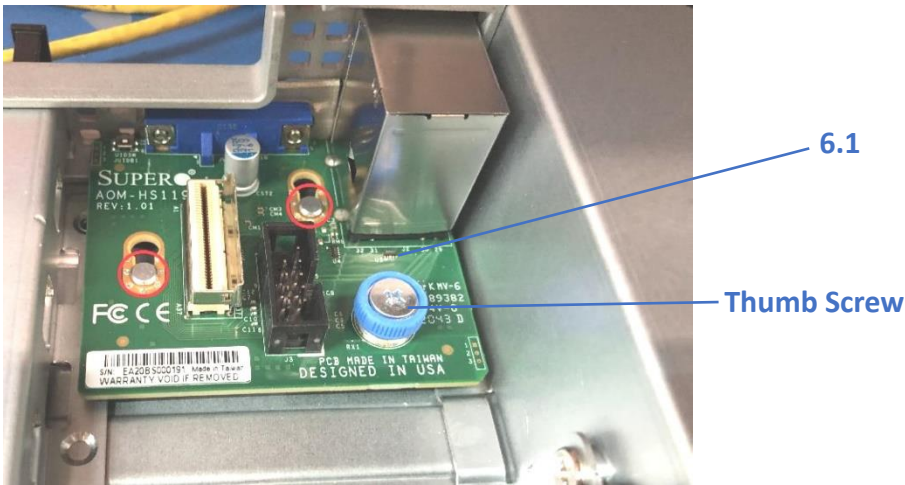

No.	Description
6.1	Add-on Module

7. Removing Fan

1. Pull on the fan using the fan tab (circled in red) and lift the fan up and out of the chassis for each fan.

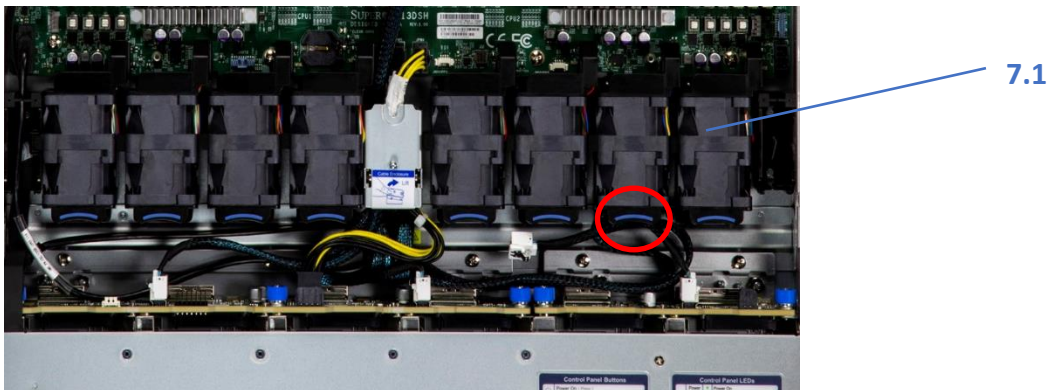

No.	Description
7.1	Cooling Fans

8. Removing Backplane

1. Ensure all the cables are disconnected and pull the backplane bracket out of the chassis.
2. Unscrew the 3 thumbscrews by hand (circled in red) and 3 screws holding the backplane using a screwdriver (circled in yellow) as shown below to remove the backplane from the system.

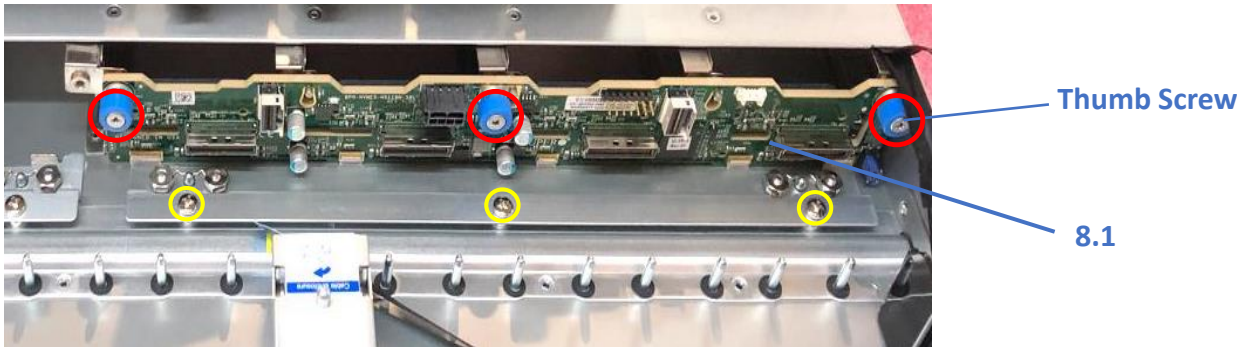

No.	Description
8.1	Backplane

9. Removing the Riser Bracket and Riser Card

1. Disconnect any cables connecting the riser cards to the system.
3. Lift the riser card bracket out from the chassis
4. Unscrew the thumb screw holding the riser card and remove the riser card from the bracket.

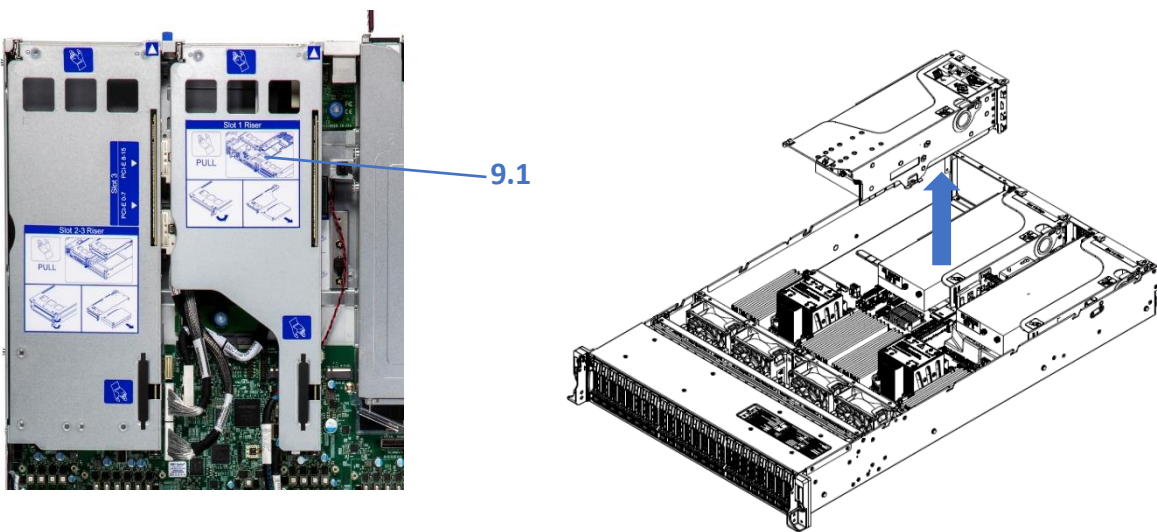

No.	Description
-----	-------------

9.1	Riser Card Bracket
9.2	Riser Cards

10. Removing Processor

1. Removing the PHM (Processor Heatsink Module) from the motherboard, first shut down the system and unplug the AC power cord from all power supplies
2. Use a T30-bit screwdriver to loosen the four peek nuts on the heatsink in the sequence of 6,5,4,3,2,1 as shown in the picture below:

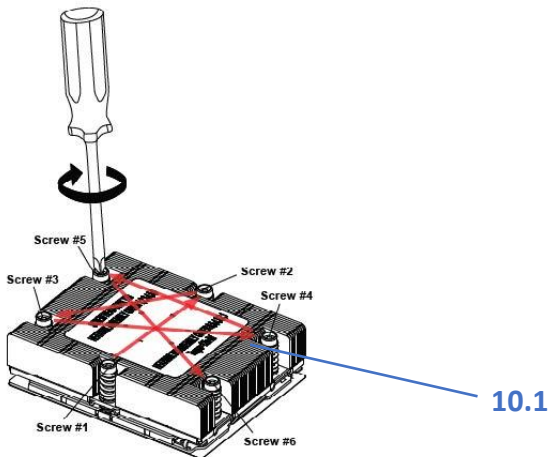

3. Once the screws have been removed, lift the heatsink module off the socket.
4. Loosen the socket screw.

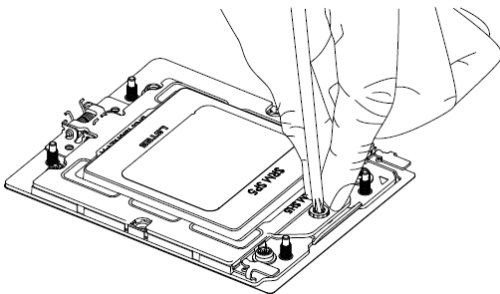

5. Gently remove the processor from the socket.

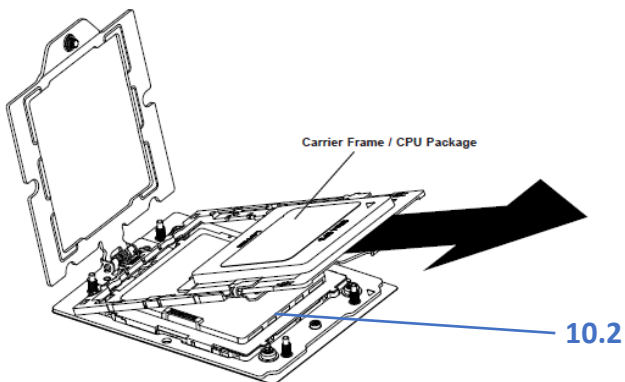

Note: Please handle the processor with care to avoid damaging it or its pins

No.	Description
10.1	Heat Sink
10.2	Processor

11. Removing DIMM

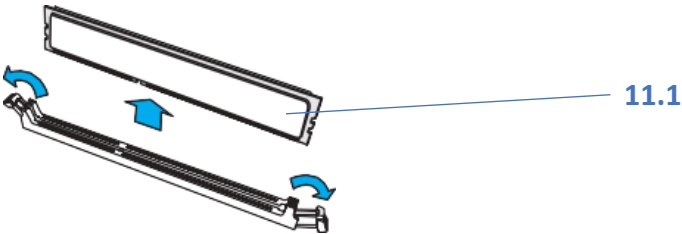

1. Hand press both release tabs on the ends of the DIMM module to unlock it
2. Once the DIMM module is loose, remove it from the memory slot

No.	Description
11.1	DIMM

12. Removing the Network Card

1. Find the slot 1 and remove the gold finger and unlock the hock.

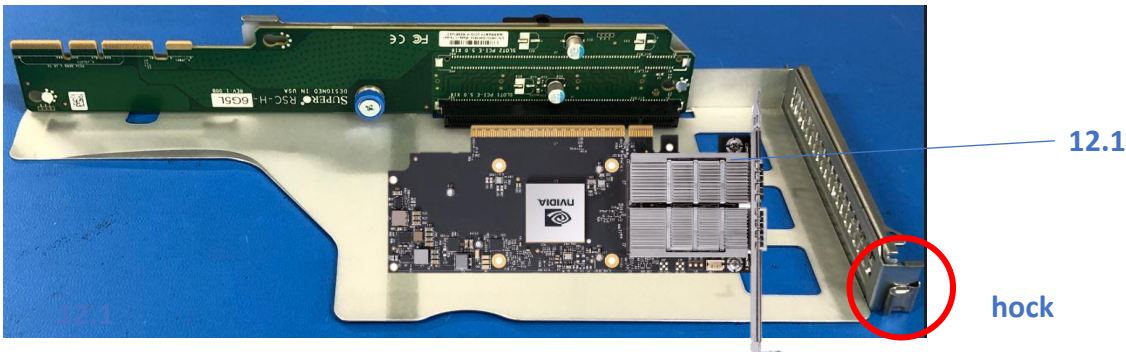

No.	Description
12.1	Network Card

13. Removing the M.2 from the Motherboard

1. Locate the M.2 on the motherboard at the J7 connector and press down on the clip holding the M.2 in place.
2. Gently pull the M.2 out of the socket.

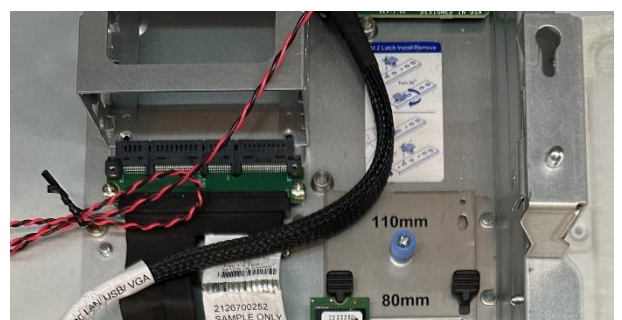

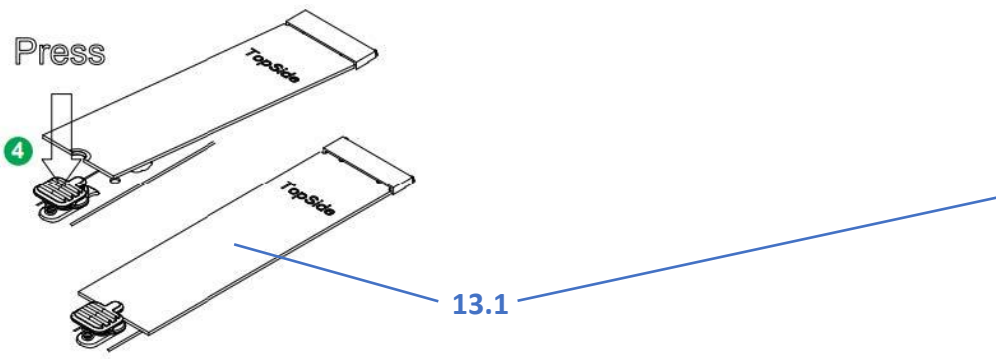

No.	Description
13.1	M.2

14. Removing the Power Supply Shroud and Air Shroud

1. Locate the Power Supply Shroud on the motherboard and lift it out of the system using the latch.

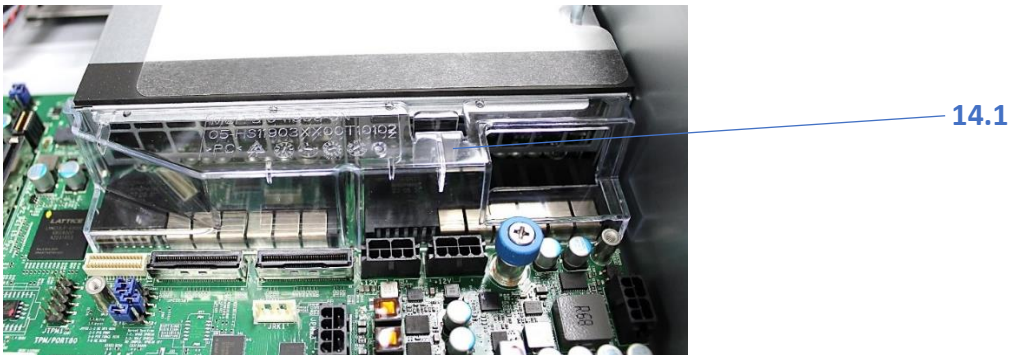

2. Locate the 2 Air Shrouds on top of the DIMM slots and CPU and pull them out of the system.

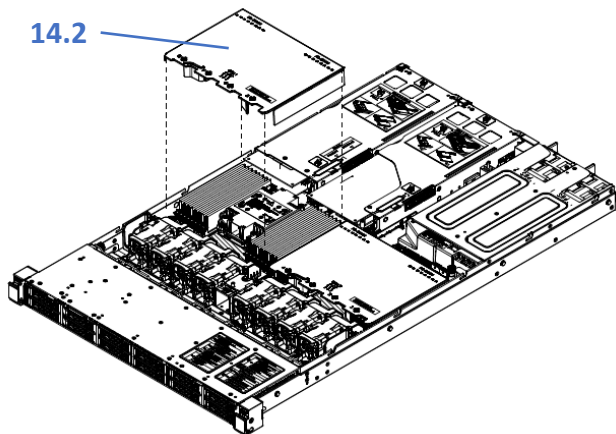

No.	Description
14.1	Power Supply Shroud
14.2	Air Shroud

15. Removing Motherboard

1. Unscrew the screws (circled in red) on the motherboard and lift the motherboard out of the chassis.
2. Push aside the small clamp that covers the edge of the battery. When the battery is released, lift it out of the holder.

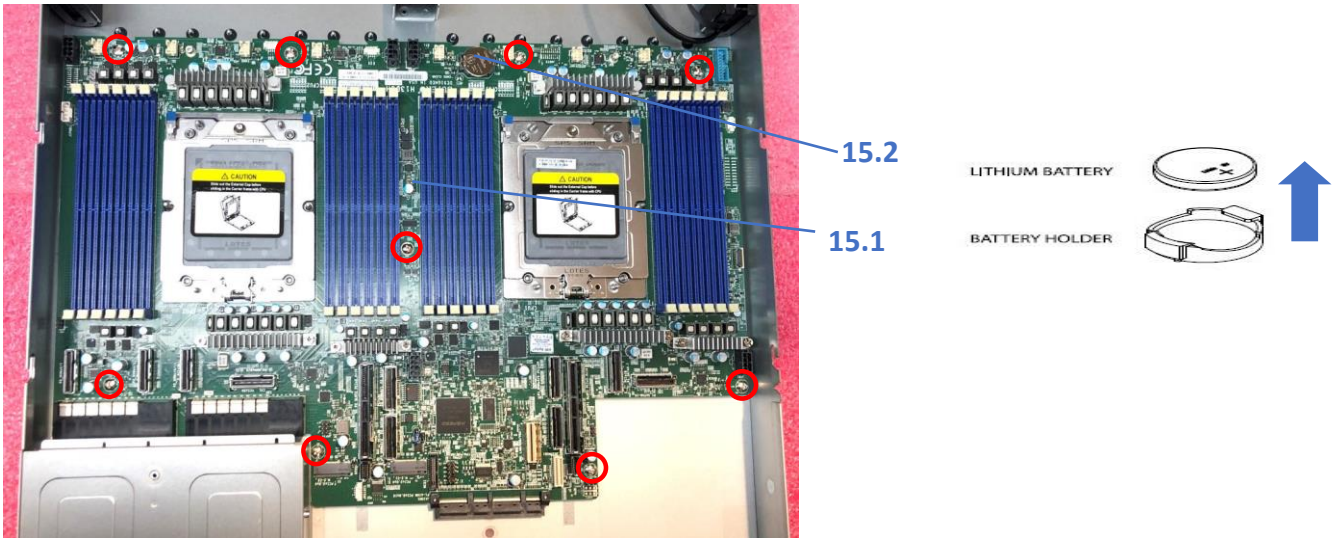

No.	Description
15.1	Motherboard
15.2	Battery

When all the steps are complete, the chassis enclosure can be recycled.